

User Manual

MX1.2+1.3 Series

Release 1.04





INDEX

1 – MX1.2+1.3 Series in a few words	4
2 – What is in the kit?	6
3 – Power	7
4 – What you can do via keyboard	8
4.1 – Set Date/Time	9
4.2 – Set backlight	10
4.3 – Set video input	10
4.4 – Counters management	11
4.5 – Reset Gear Calculation	11
4.6 – GPS & Tracks management	12
4.7 – Wi-Fi Management	13
4.8 – System Information	13
4.8.1 – Net Info page	14
5 – Wi-Fi configuration	15
5.1 – Configuring MX Series loggers as an access point (AP)	16
5.2 – Adding MX Series loggers to an existing network	19
5.3 – Wi-Fi network settings	21
5.4 – The Internet connectivity	23
5.5 – Connection issues	23
5.6 – Working on Mac™ with virtualized Windows™	24
5.7 – Connected device visualization issues	26
6 – MX Series and the PC	27
6.1 – Connection to the PC	27
6.2 – Configuration of MX Series	27
6.2.1 – Channels configuration	28
6.2.2 – ECU Connection and configuration	32
6.2.3 – RPM	34
6.2.4 – CAN2 Stream configuration	37
6.2.5 – CAN Expansions configuration	38
Setting LCU-One CAN	39
Setting Channel Expansion	40
Setting TC Hub.	41
Setting RIO_2a.	42
Setting Shift Lights Module.	44
Setting Steering Wheel 3 or GS Dash	45
6.2.6 – Math channels configuration	48
6.2.7 – Status variables configuration	49
6.2.8 – Parameters configurationE	50
6.2.9 – Shift Lights and Alarms configuration	51
6.2.10 – Trigger commands configuration	55
6.2.11 – Icons manager configuration	58
6.2.12 – Display configuration	61
6.2.13 – SmartyCam stream setting	63
6.2.14 – CAN Output configuration	64
6.2.15 – Transmitting the configuration to MX loggers	65
6.3 – Managing a track on MX Series with Race Studio 3	66
6.4 – ECU Driver builder	69
6.5 – The device window	71
6.5.1 – Online value forcing	72
7 – On the track	74
8 – Data recall	74
9 – Data download and analysis	75
10 – New firmware upgrade	76
11 – Connection with the expansions	77
11.1 – Rear cameras connection and management	77
12 – Technical specifications and drawings	80



12.1 – MX Series Pinout and dimensions
12.2 – MX series harnesses

81
86



1 – MX1.2+1.3 Series in a few words

What is MX1.2+1.3 Series?

MX1.2+1.3 Series (from here onwards MX) is a complete range of dashes with different features that offers different dimensions, flexibility, usability and that may manage a wide range of channel inputs.

It features:

- ECU connection (CAN, RS232 and K-Line)
- 4 speed inputs
- 1 RPM input
- 8 analog inputs
- 2 analog video camera inputs
- up to 8 configurable display pages
- a huge tracks database to automatically selects the track you are racing on
- from 5 to 8 alarm LEDs
- 10 RGB LEDs that you may configure to clearly show if you are improving or not.

What about ECU connection?

MX Series manages CAN, K-Line and RS232 ECU communication lines and its huge database includes more than 1500 ECU protocols.

Is MX Series an expandable logger?

Yes. MX Series can be connected to various AiM expansions like GPS Module, Channel Expansion, TC Hub and LCU-One CAN to maximize your engine performances and to AiM SmartyCam to see your track performances on your PC with all the values you need in overlay.

Anything else?

You may connect up to two additional optional back cameras to the dedicated input in order to show a reverse mirror image directly on its display.



The table here below shows the difference among the loggers.

FEATURE	MXG 1.2	MXG 1.3	MXP	MXP 1.3	MXS 1.2	MXS 1.3	MXT 1.3
Display	7" TFT		6" TFT		5" TFT		10" TFT
Resolution	800*480 pixels						1280*480 pixels
Contrast	1000:1		600:1				1100:1
Brightness	700cd/m ² - 1,100 Lumen						800cd/m ²
Light Sensor	Yes						
Alarm Display Icons	Yes, freely configurable						
Alarm RGB LEDs	8 configurable		5 configurable		6 configurable		
Shift Lights	10 configurable RGB LEDs						
CAN Connection	3						
ECU Connection	CAN, RS232 or K-Line to 1.000 + industry leading ECUs						
Expansion Modules	GPS Module, Channel Expansion, TC Hub (necessary to connect MX 1.3 and MXT to thermocouples sensors), Lambda Controller, SmartyCam HD						
Analog Inputs	8 fully configurable, max 500 Hz each						
Digital Inputs	4 speed inputs, lap signal, coil RPM input						
Digital outputs	2 (1A each)						
Second CAN	Yes						
WiFi connection	Yes						
Inertial platform	Internal 3 axis gyro, magnetometer and ±5G accelerometer (MXG 1.2, MXP, MXS 1.2 only)						
Internal Memory	4Gb						
Body	Anodized Aluminium						
Pushbuttons	Metallic						
Connectors	2 Autosport +1 Binder						
Dimensions	237*127.6*26 mm		189.6*106.4*24.9		169.4*97*23 mm		278*135*43.2 mm
Weight	950g		640g		530g		1200 g
Power Consumption	400mA						450mA
Waterproof	IP65						

2 – What is in the kit?

MX Series kit includes:

- MX Series logger shown below
- 37 pins Deutsch connector harness with mini USB cable
- USB adapter cable (from mini to standard USB)
- GPS09 Module



3 – Power

The power is managed by two pins of the 37 pins connector:

- Pin 1: Power (9-15 Volts)
- Pin 2: Ground

They must be connected as shown in the following diagram.

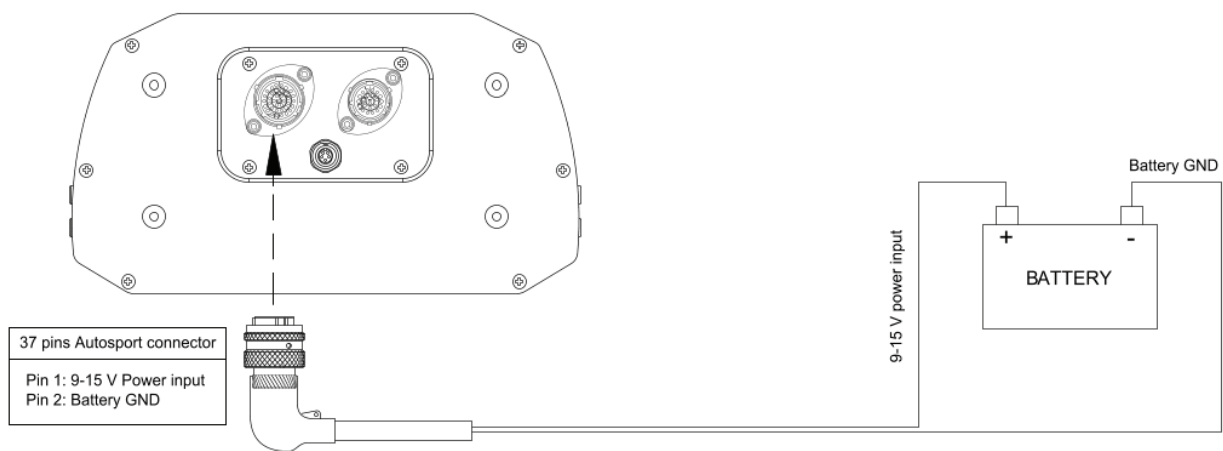

4 – What you can do via keyboard

MX Series needs to be configured via software but there are some functions you can manage via the device lateral buttons,

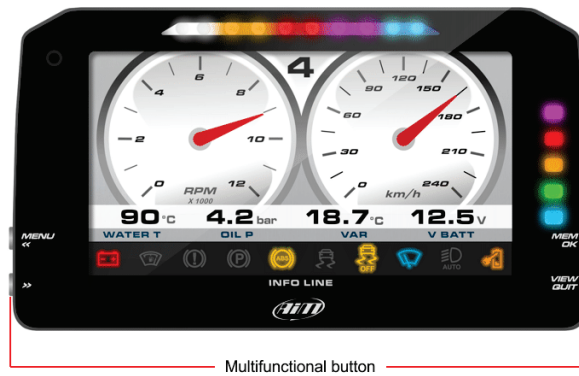

Press “Menu” button and this page appears.

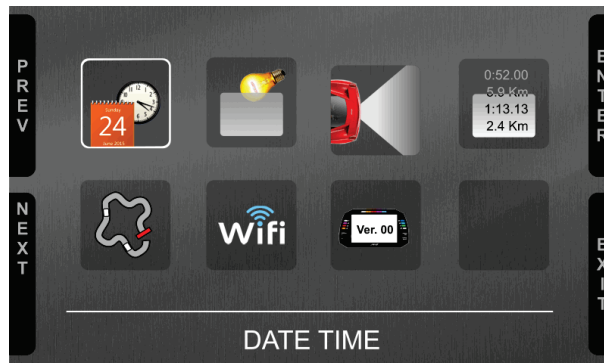

The icons are to manage:

	Date/Time		Counters		Wi-Fi connection
	Backlight		Reset Gear Calculation		System Info
	Video In		GPS and Tracks		

4.1 – Set Date/Time

Here you can:

- set time format: 12H or 24h; press “CHANGE” to switch among the options and “NEXT” to scroll to Date format
- set date format: MM/DD/YY or DD/MM/YY or YY/MM/DD; press “CHANGE” to switch among the options
- “GPS Date Time Sync” default setting is “Enabled” (left image below); this means that date and time comes from MX GPS. Press “CHANGE” to disable the synchronization and set date and time manually
- press “NEXT” so start setting time (right image below)

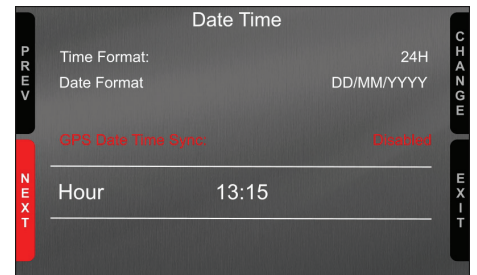
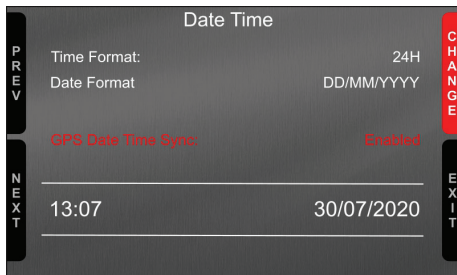

The system enters in manual date/time mode. With reference to the images below:

- press “NEXT” to start setting time → hour becomes selected (13 in red below) → press “SELECT” and hour becomes editable (13 on red background below) → Use “DEC” and “INC” to set hour →
- press “DESEL” and “INC” button switches to “NEXT”: press it to switch to minute option: press “SELECT” and set minute
- press “DESEL” and then “NEXT” and you come back to “Hour”; press “CHANGE” and “Hour” switches to “Date”: press “NEXT”
- set day, month and year as for time setting and press “EXIT”; you come back to “Time Format”: press “EXIT” to save and quit

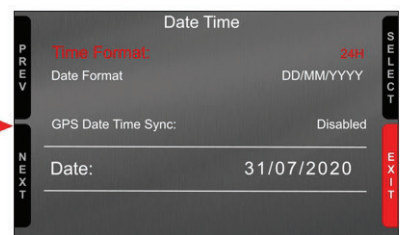
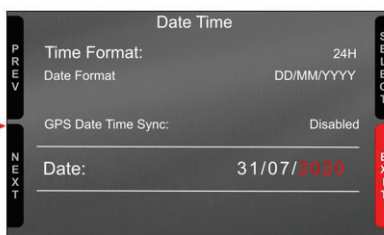
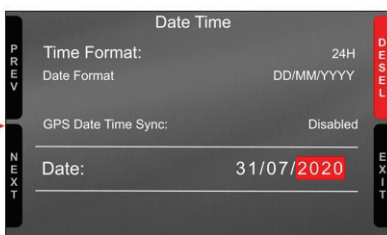
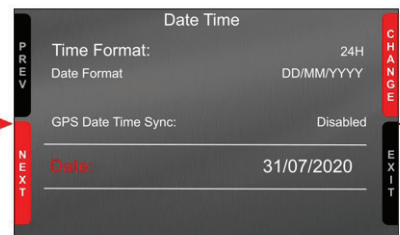
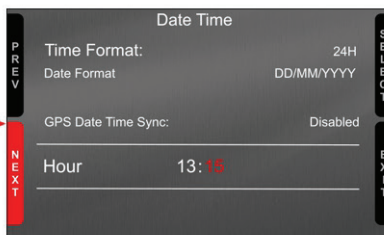
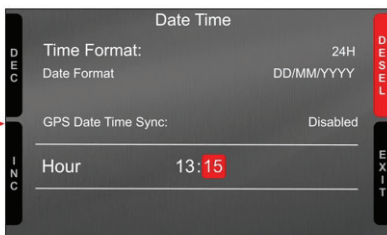
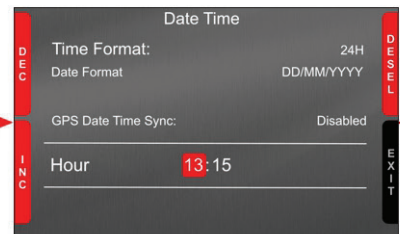
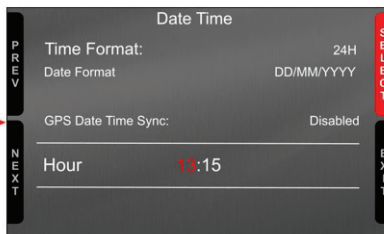
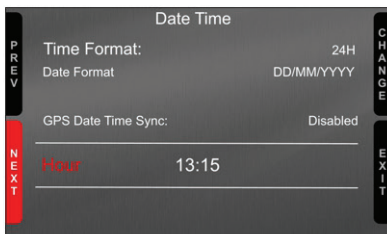



4.2 – Set backlight

The brightness of the display and LEDs may be adjusted in two ways, depending on the light captured by a dedicated sensor integrated in the dash

- **AUTOMATIC:** in case ambient light is higher than a defined threshold, the brightness is reduced; you can set day and night brightness level as well as the brightness threshold value that switches from day to night mode (left image below)
- **MANUAL:** you may define the brightness of the display and LEDs choosing among some values: 20%, 40%, 60%, 80%, 100% (right image below).



4.3 – Set video input



Video In page manages up to two additional optional back cameras (that cannot be logged).

They are to be connected to the Binder 712 female connector rear central of MX Series logger, as shown in the pinout you find at the end of this user guide. Please refer to paragraph 11.1 ("Rear cameras connection and management") for further information.

Features to set are:

- Input: Video 1 / Video 2
- State: Enabled/Disabled
- Format: NTSC/PAL
- Brightness and Contrast from 10 to 100%

Use:

- "CHANGE" button to set each feature
- "NEXT" button to scroll the features
- "EXIT" to save and quit

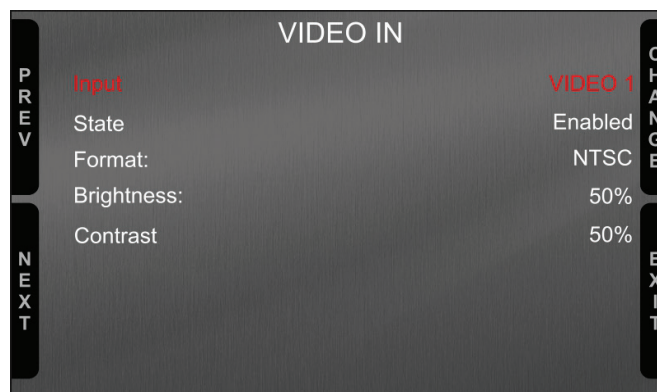

4.4 – Counters management

MX Series features 4 user odometers, labelled User 1 – User 4, plus a non-resettable System Odometer. All odometers are shown on the configuration software Race Studio 3 too (see chapter about MX Series and the PC).

Each odometer can be activated/deactivated and/or reset. To manage an odometer select it and press “CHANGE”.

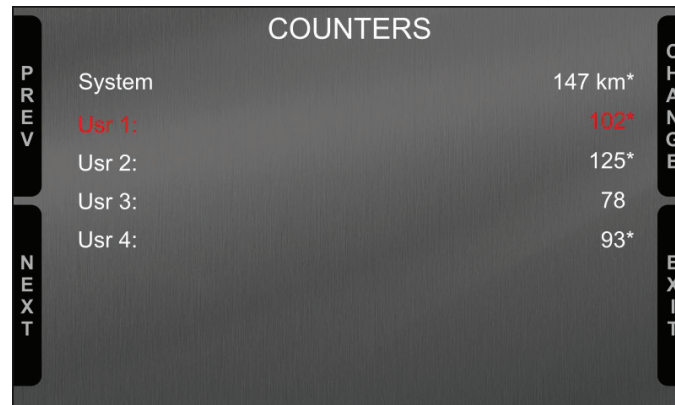

4.5 –Reset Gear Calculation

With “Reset Gear Calc” function it is possible to re-start gear calculation. This function is very useful in case something has been modified on the vehicle or if the gear calculation is for any reason invalid or failed. **For this function to be available it is necessary that:**

- the configuration set in Race Studio 3 includes calculated gear (see paragraph 6.2.6 for further information)
- gear calculation has been performed at least once.

To reset gear calculation press “OK”.

The system notifies that gear calculation is being performed. At this point it is necessary to run a track lap engaging all gears and leaving each gear engaged for about 5 seconds. When the max gear has been reached the system records the calculation and starts showing the engaged gear on the display (if the selected layout includes this field) as well recording the gear. For further information concerning gear calculation see “FAQ” section concerning MX series, configuration paragraph of www.aim-sportline.com.





4.6 – GPS & Tracks management

MX Series can be used on track thanks to AiM GPS09 Module included in the kit. This is used for:

- Lap time calculation
- Speed calculation
- Predictive lap time calculation

To calculate these data the system needs to know the start/finish line coordinates of the racetrack you are racing on; MX Series comes with a long list of the world main tracks, constantly updated by our technicians and automatically loaded to your PC when you run Race Studio 3 software and a connection to the Internet is available.

MX Series provides two track selection modes: automatic and manual.

Automatic:

MX Series automatically recognizes the track you are running on, loads the start/finish line and the possible splits coordinates and calculates lap and split times without optical/magnetic receiver. This is the best mode in most cases.

Manual:

Allows to manually select the track from the internal database.

This mode is to be preferred when multiple track configurations are available nearby. In this case MX Series would anyway recognize the track but would need at least one complete track lap.

You can scroll the list of available tracks choosing among these options:

- nearest: shows only tracks in a 10 km distance
- all: shows all tracks stored in the system in alphabetical order
- custom: shows only the tracks you have previously created with Race Studio 3 software (see paragraph 6.3)

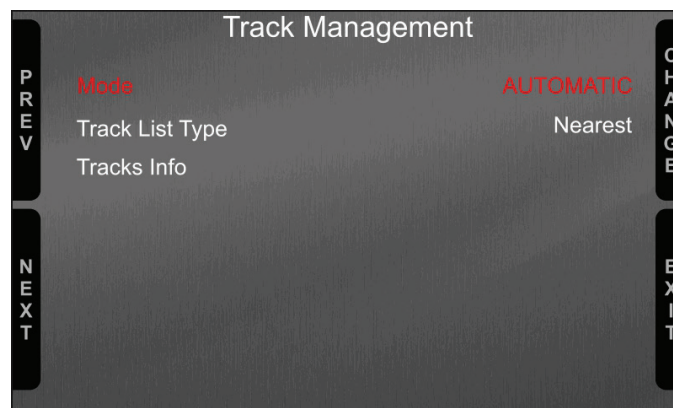

4.7 – Wi-Fi Management

Here you can manage Wi-Fi as well as select the channel to be used (expert users only) and reset its configuration. **Wi-Fi modes** are:

- ON
- Auto: switches Wi-Fi on when the vehicle is stopped and switches it automatically off when MX Series starts recording according to the setting you performed in “Parameters” page of Race Studio 3 software (see paragraph 6.2.8 for further information)
- OFF

Select Channel function **is for expert users only**; here it is possible to select which Wi-Fi channel to use; available options are:

- AUTO (default – recommended)
- 1
- 6
- 11

“**Wi-Fi reset CFG**” resets Wi-Fi configuration and is very useful if you do not remember the Wi-Fi password.



4.8 – System Information

This page shows MX info as well as firmware and booter version; if any expansion is connected (please note GPS Module is considered an expansion too) “Net Info” option is shown allowing to enter the page with all information about the expansions connected to MX.

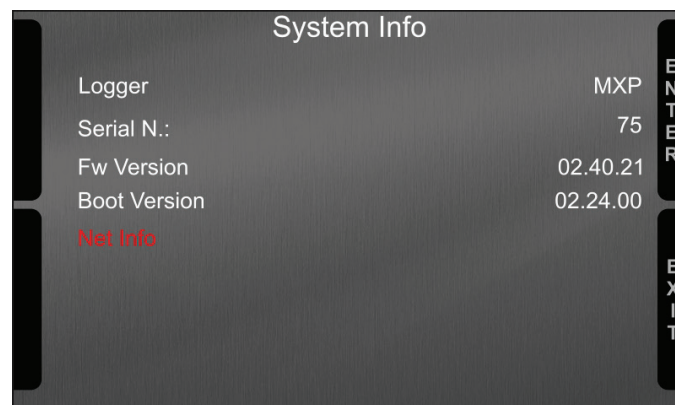

4.8.1 – Net Info page

Entering “System Info” page with any expansion connected to MX the system places directly on “Net Info” option and pressing “ENTER” it enters in the page showing all information concerning the devices connected to MX.

For all expansions the system shows serial number and firmware version. In the example below AiM network includes:

- GPS with serial number 0926677 and firmware version 35.64.00
- Channel Expansion with serial number 2000962 and firmware version 40.63.00

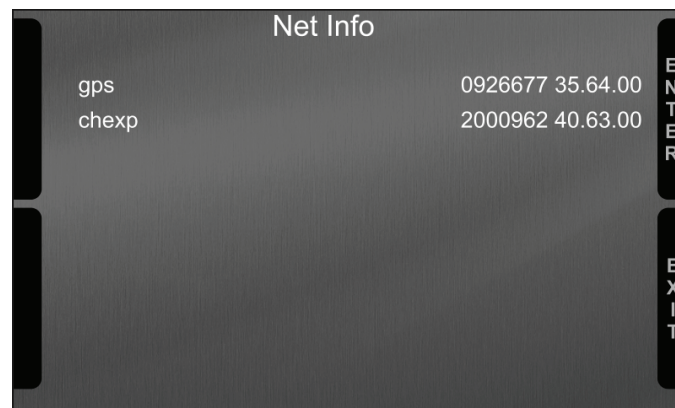

5 – Wi-Fi configuration

Two possible Wi-Fi connection modes are available.

1 – As an access point (AP – default)

This is the ideal configuration for one only device and one only computer. In this situation MX Series creates a Wi-Fi network and works as an Access Point the PC can be connected to.



2 – Existing network (to connect to an existing Wi-Fi network – WLAN)

This mode is complex and implies an external access point (AP) but it is also more flexible and powerful because allows the communication among more than one device and more than one computer in the same network. MX Series and the PC must connect to an existing Wi-Fi network made by a device that works as an external access point.

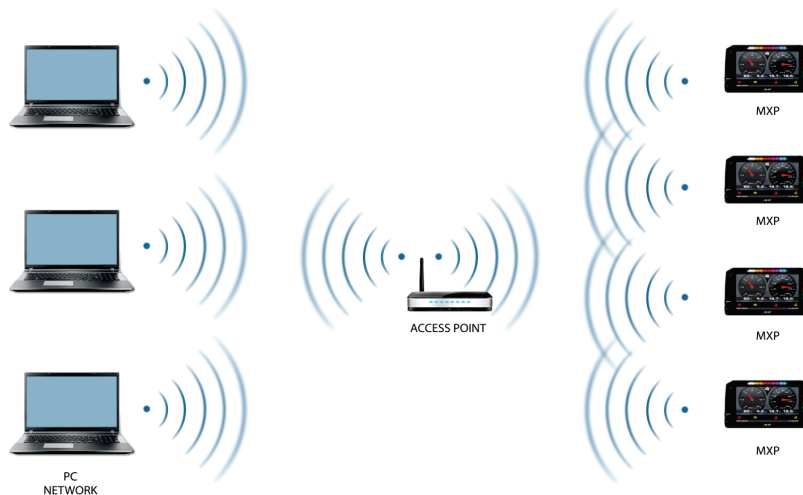

When working in WLAN mode MX Series has two available security levels:

- network authentication: network password
- device authentication: MX logger password

Both levels allow the use of different strategies. A PC in WLAN, for example, can see several AiM devices but can only communicate with those he knows the password of.

Forgetting the password Wi-Fi configuration can be reset from MX Series menu as explained at paragraph 4.7.

5.1 – Configuring MX Series loggers as an access point (AP)

This is MX Series default configuration and is the easiest and most direct connection mode, ideal to communicate with one MX Series logger using one PC. It is free and so completely accessible by anyone. Please set an access password as soon as possible.

To establish a Wi-Fi connection:

- ensure that the Wi-Fi is enabled
- read MX Series Name (75 in the image below)

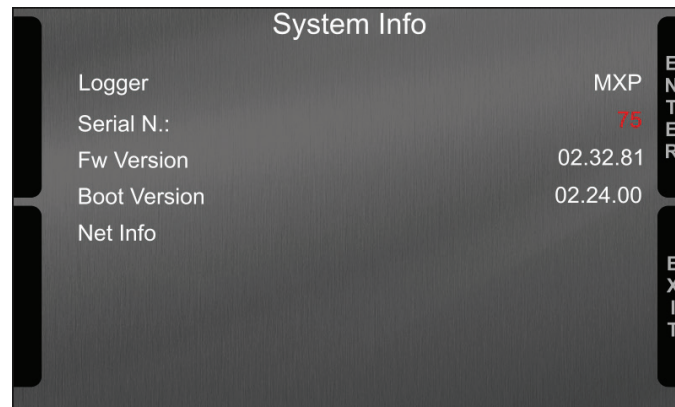

- run Race Studio 3
- click Wi-Fi icon and select your device
- in a few seconds the connection is established

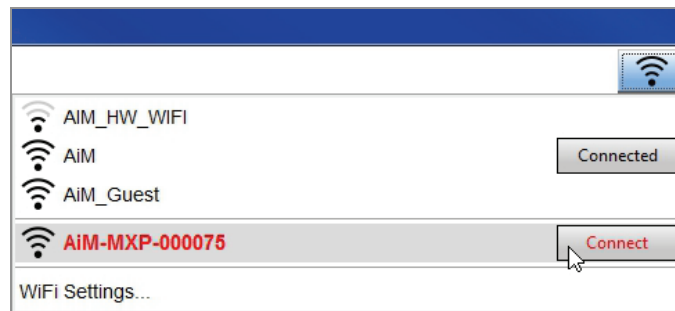



To set other parameters create a unique password to protect the device/ network. With a password the communication is safe and encrypted using WPA2-PSK standard.

Characters allowed in the password are all letters, also capital, all digits and these characters: '+_{}\$£!/?^#@*\\"=~/%'
"Space" type can be used if it is not the first one because this could cause incomprehension in some Windows™ versions.

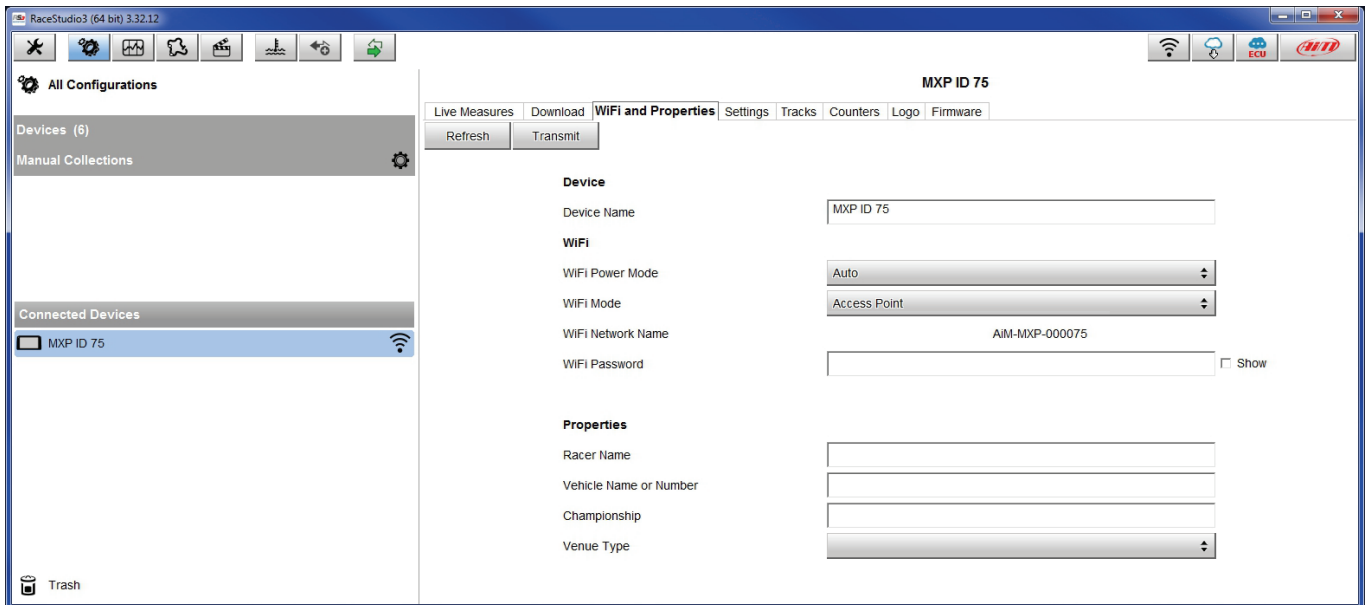

This AP or SSID name is unique for the device.

An example of name is: "AiM-MXS12-02523" where:

- "AiM" is the prefix of all AiM devices
- "MXP" is the device identifier
- "000075" is the device serial number assigned by the factory.

To make a device more recognizable a name can be added to the SSID. With the limit of eight characters. Allowed characters are all letters, capital too, all digits and these characters: '+ - _ () [] {}!.

"Space" type can be used provided that it is not the first one because it can cause incomprehension in some Windows™ versions.

Adding, for example, the driver's name, Tom Wolf, the network name (SSID) becomes:

"AiM-MXP-000075-TomWolf"

Once all parameters set click "Transmit". MX Series logger reboots and is configured with the new parameters. If MX Series logger is protected by a password, as recommended, Race Studio 3 will ask that password to authenticate.

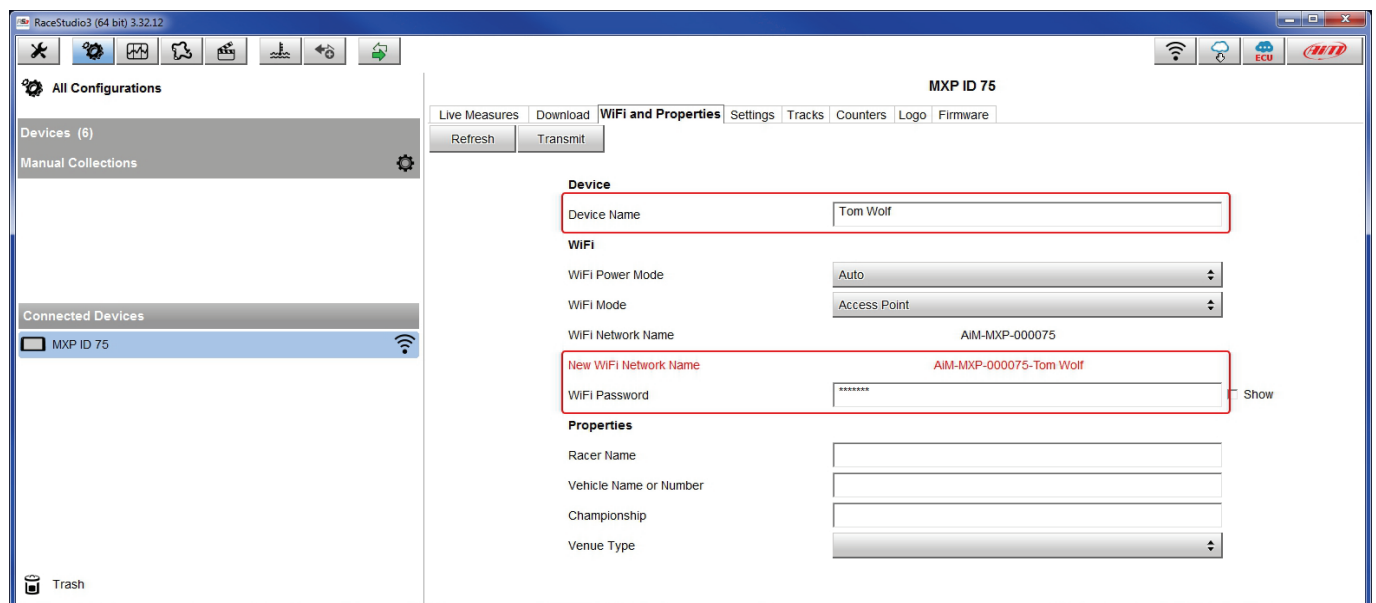

Please Note: the same Wi-Fi connection can be created with the operative system tool.

Once the device has been authenticated in the Wi-Fi network it can communicate using Race Studio 3.

5.2 – Adding MX Series loggers to an existing network

This situation is ideal for a team with multiple drivers and staff members and is desired to communicate with one or more AiM devices using the same PC network. Each MX Series logger can have its password that adds another security and privacy level to the network.

Race Studio 3 will show all MX Series loggers connected to the same network under “Connected devices” label, bottom left of the software page: click the device.

Enter “Wi-Fi and properties” tab and set it on “Existing Network”; fill in network name, network password and device password.

Transmit the network settings to the device clicking “Transmit”: it reboots and joins that network.

Please note: the only admitted password are those following WPA2-PSK standard.

To complete this procedure use Race Studio 3 software as here explained.

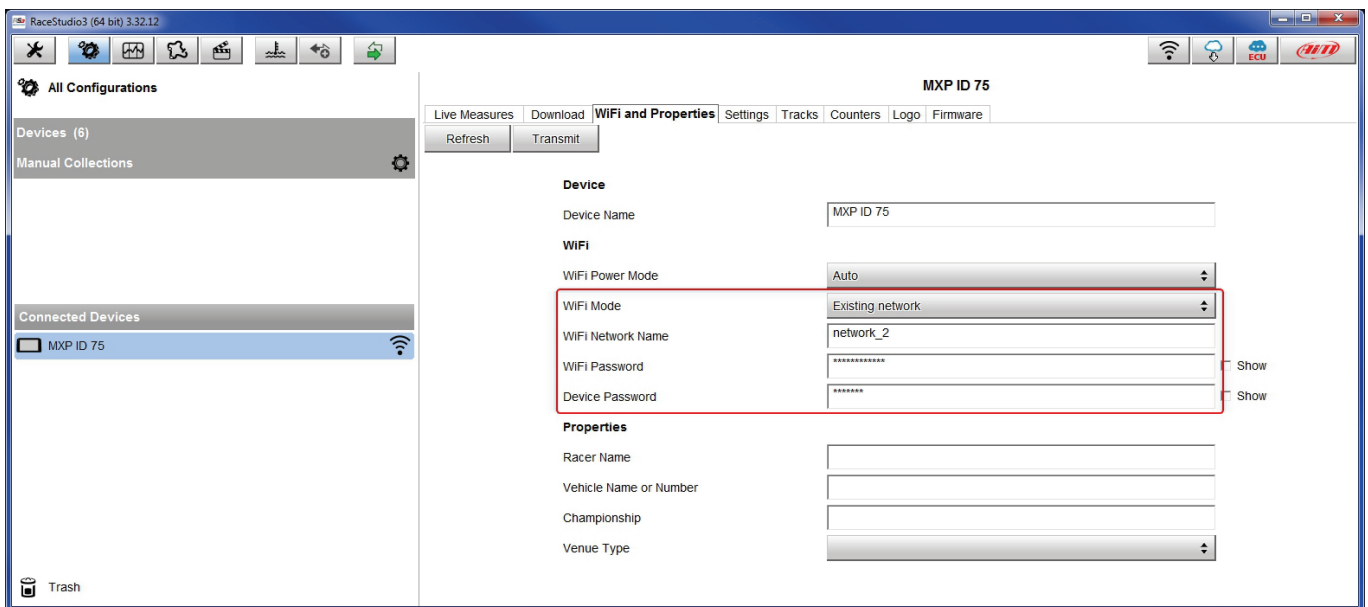

Here above is shown a device “MXP ID 75” that switched from AP to WLAN mode (Existing Network).

Network name is “network_2” and does not work with free access because is protected by a password.



To obtain connectivity on the device the PC has to be authenticated to the same network as shown here below.

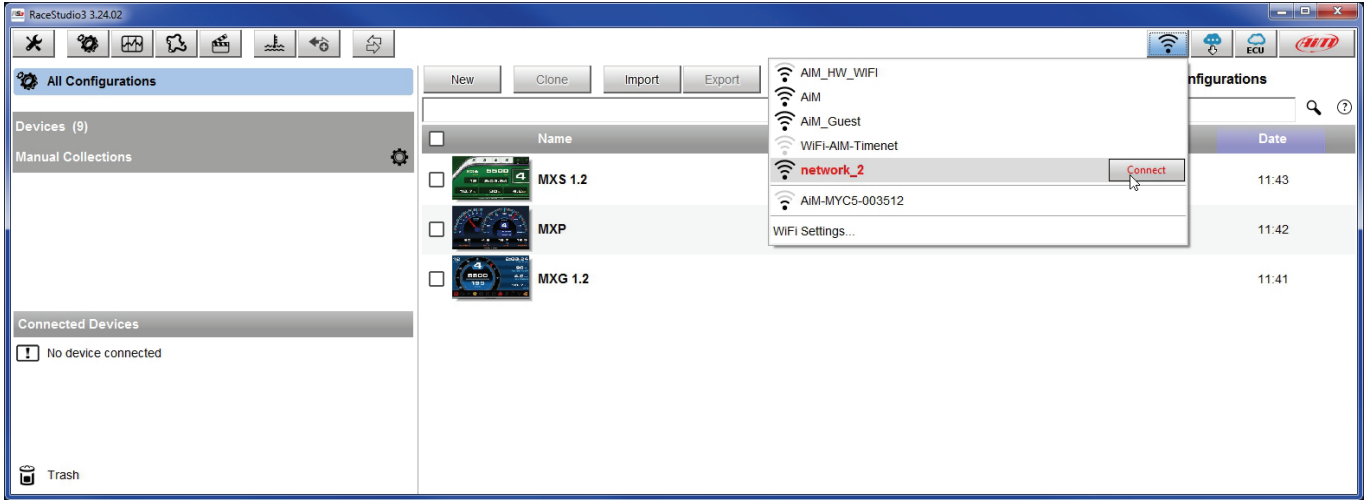

When the PC is authenticated to the network called “network_2” it can see all devices you configured to access the same network. In the image below three AiM devices are connected to the same “network_2” WLAN.

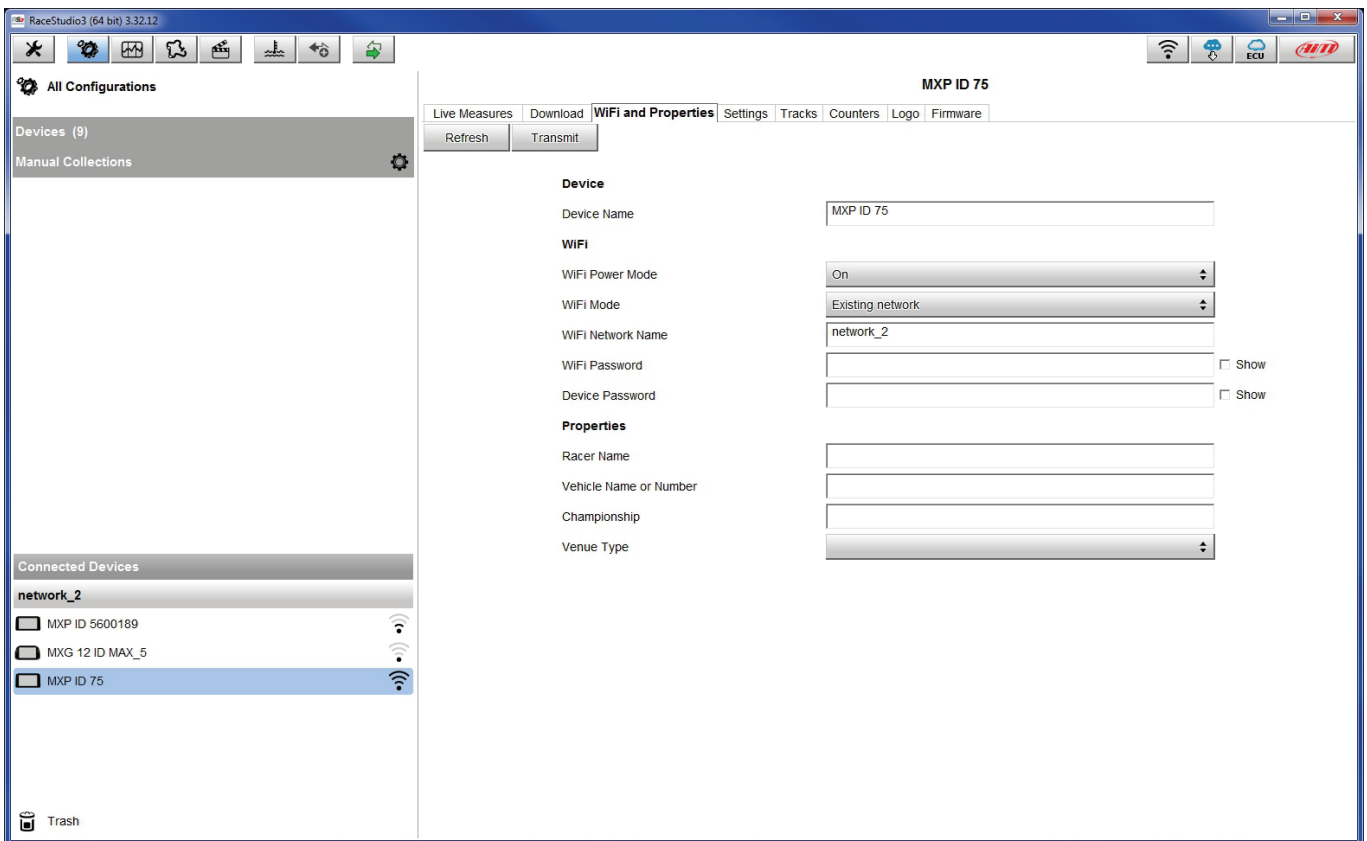

5.3 – Wi-Fi network settings

In this chapter is a short description of how to configure a WLAN including AiM devices and a PC.

Here below is an example of configuration.

ROUTER SETTINGS

Use this section to configure the internal network settings of your router. The IP Address that is configured here is the IP Address that you use to access the Web-based management interface. If you change the IP Address here, you may need to adjust your PC's network settings to access the network again.

Router IP Address :

Subnet Mask :

Device Name :

Local Domain Name : (optional)

Enable DNS Relay :

DHCP SERVER SETTINGS

Use this section to configure the built-in DHCP Server to assign IP addresses to the computers on your network.

Enable DHCP Server :

DHCP IP Address Range : to

DHCP Lease Time : (minutes)

Always Broadcast : (compatibility for some DHCP Clients)

NetBIOS announcement :

Learn NetBIOS from WAN :

NetBIOS Scope : (optional)

NetBIOS node type :

- Broadcast only (use when no WINS servers configured)
- Point-to-Point (no broadcast)
- Mixed-mode (Broadcast then Point-to-Point)
- Hybrid (Point-to-Point then Broadcast)

Primary WINS IP Address :

Secondary WINS IP Address :

For better network performances, we suggest the use of a network device equipped with a DHCP server and using 3x3 MIMO technology like, for example a Linksys AS3200.

To maximize the bandwidth the Internet should not be allowed on this WLAN; this means the DHCP server should be configured without any DNS address nor gateway by default.



The parameters for the device network configuration in this example are:

- **Wireless network name: Network_2**
It means that the WLAN network name is "Network_2." A PC has to be authenticated in this network to interact with any AiM device of this network.
- **Gateway address: 192.168.0.1**
primary DNS server: 0.0.0.0
secondary DNS server: 0.0.0.0
(These settings prevent Internet connectivity on this WLAN.)
- **Subnet mask: 255.255.255.248**
Enable DHCP server: yes
DHCP IP address range: 192.168.0.2 to 192.168.0.6

These settings enable a DHCP server running on this WLAN and provide an IP address in a 2-6 range. This means that this network allows 5 network hosts.

The number of devices on a WLAN network depends on the subnet mask. Here below are typical examples of network masks and IP addresses range.

The configuration in bold is the one we suggest (if a greater number of devices is not needed), being the one that makes it easier and quicker for Race Studio 3 the identification of the devices in the network.

Subnet mask:	IP address range:	Number of devices:
255.255.255.0	192.168.0.1 – 254	254
255.255.255.128	192.168.0.1 – 126	126
255.255.255.192	192.168.0.1 – 62	62
255.255.255.224	192.168.0.1 – 30	30
255.255.255.240	192.168.0.1 – 14	14
255.255.255.248	192.168.0.1 – 6	6



5.4 – The Internet connectivity

For an optimal speed of AiM device(s) it is recommended not to allow the Internet on the same network and to set the WLAN in the same way.

The Internet access can of course be allowed on the network but this would degrade the communication.

This slightly slower speed can be suitable but a second Wi-Fi connection through an additional hardware (NIC) is to be preferred. This configuration would provide an optimal speed of the data network of your AiM device(s) and at the same time would provide an internet connectivity with the second NIC.

5.5 – Connection issues

It can occur that MX Series logger is correctly connected to Race Studio 3 via Wi-Fi but the user interface does not show it. This may be because Wi-Fi port setting is set with a static IP. To switch it to dynamic (DHCP):

- open "Network and sharing centre" in the Windows™ research engine
- right click on the Wi-Fi connection and a panel shows up
- select "Properties" option
- double click on "Internet Protocol version 4 (TCP/IPv4)"
- verify that option "Obtain an IP address" is active

For further information refer to FAQ section, Wi-Fi of www.aim-sportline.com.

5.6 – Working on Mac™ with virtualized Windows™

Race Studio 3 only works on Windows™ operative systems; Mac users can use a virtualized Windows™ machine.

The main problem is that the host OS (Mac) must share its Wi-Fi interface with the virtualized operative system (Windows) as Ethernet interface and not as Wi-Fi interface.

Configuring Parallels(™)

Select “Menu -> Configure...” in Parallels.

Press “Hardware” – top on the page that shows up – and select “Network” in the drop-down menu on the left. Right on the configuration panel set "Type" field on “Wi-Fi”. Then select the device to communicate with.

To ensure that the communication works select “Open Network preferences...” menu.

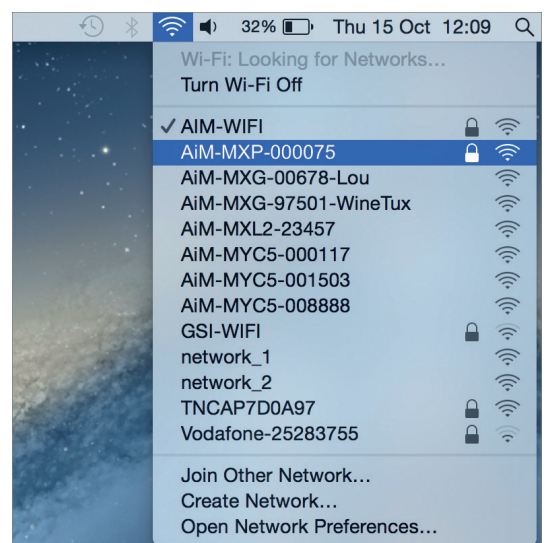
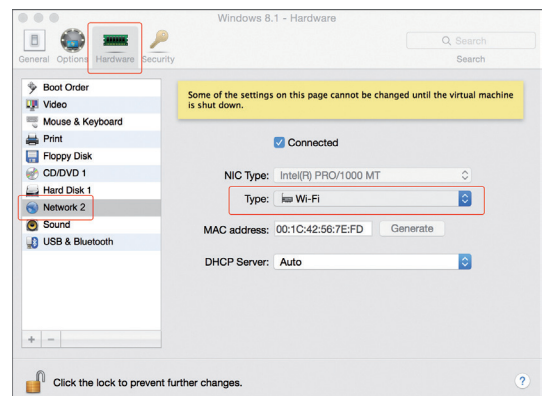
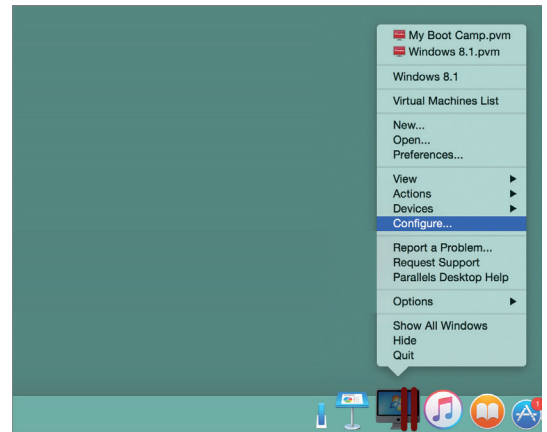

Verify that the status in the window that shows up is “Connected” and that the IP address associated is, for example, 10.0.0.10 (could be 10.0.0.11, 10.0.0.12, or generically 10.0.0.x).

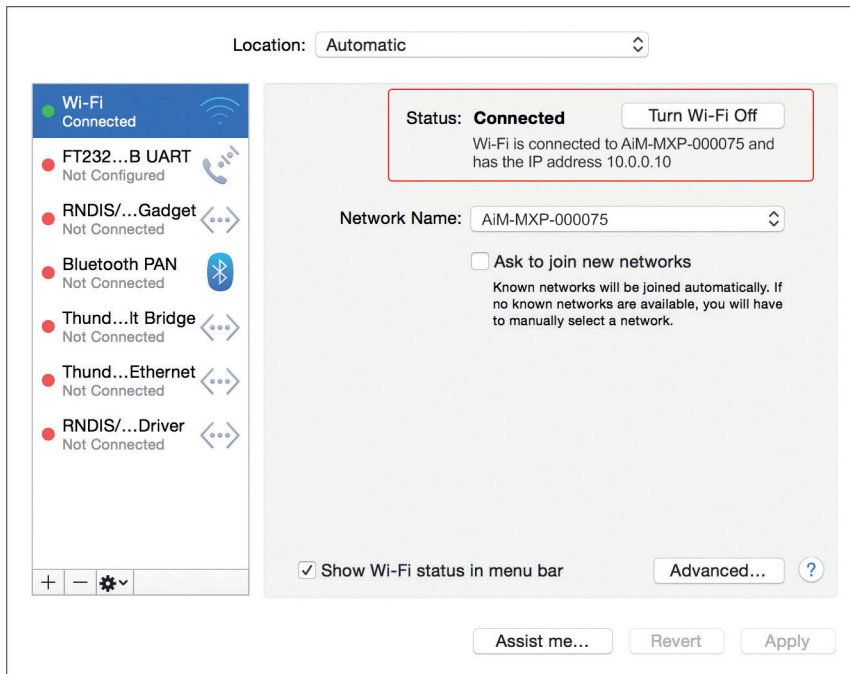

To enable Race Studio 3 correctly working on a Mac with virtualized Windows™.

- press Wi-Fi icon
- select “Wi-Fi Settings” option

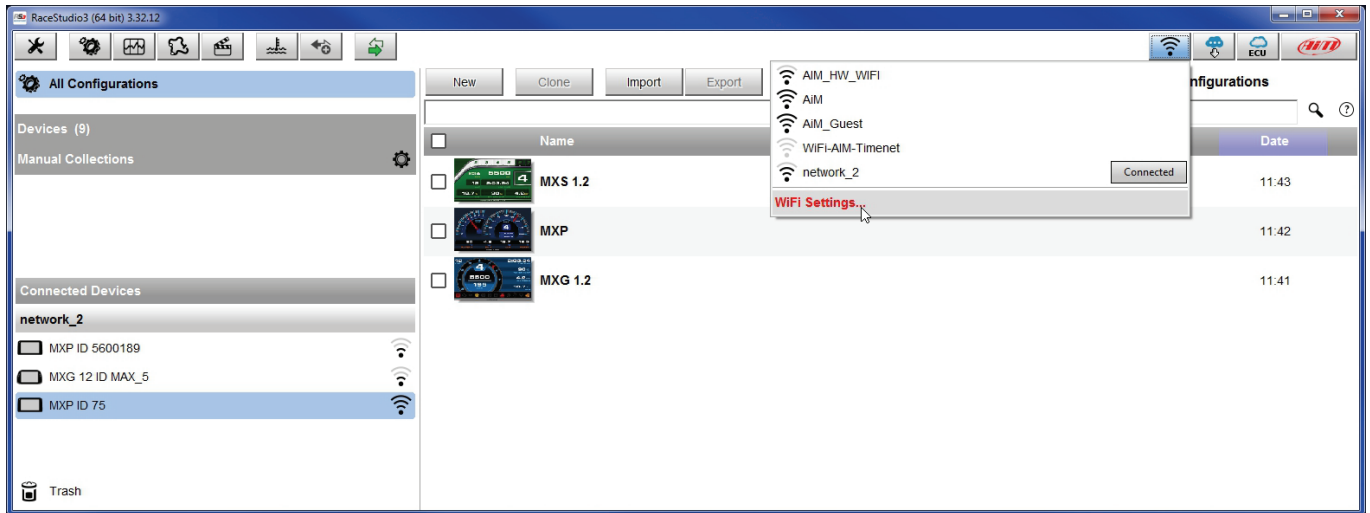

- enable the checkbox shown here below.



5.7 – Connected device visualization issues

It may occur that using Race Studio 3 on an iMac with virtualized Windows the device connected via Wi-Fi takes some time to be shown in the network or is not shown at all. This is why we always suggest using a Wi-Fi (WLAN) router.

This router work as an Access Point allowing more external devices to connect to its network. MX Series logger Wi-Fi configuration is to be set on Existing Network as explained before.

6 – MX Series and the PC

Using AiM Race Studio 3 software you can configure MX Series, manage its tracks database as well as check other device functions through Race Studio 3 device window.

6.1 – Connection to the PC

MX Series can be connected to the PC via Wi-Fi or using the USB cable included in the kit: plug it in the cable labelled “USB” of MX Series 37 pins connector harness and in the PC USB port.

6.2 – Configuration of MX Series

Once MX Series connected to the PC

- click “Configurations” icon and configurations page appears
- click “New” and new configuration panel appears: select an MX Series logger and press “OK”; when performing subsequent configurations “Select Configuration” panel shows on top the last four devices you configured.

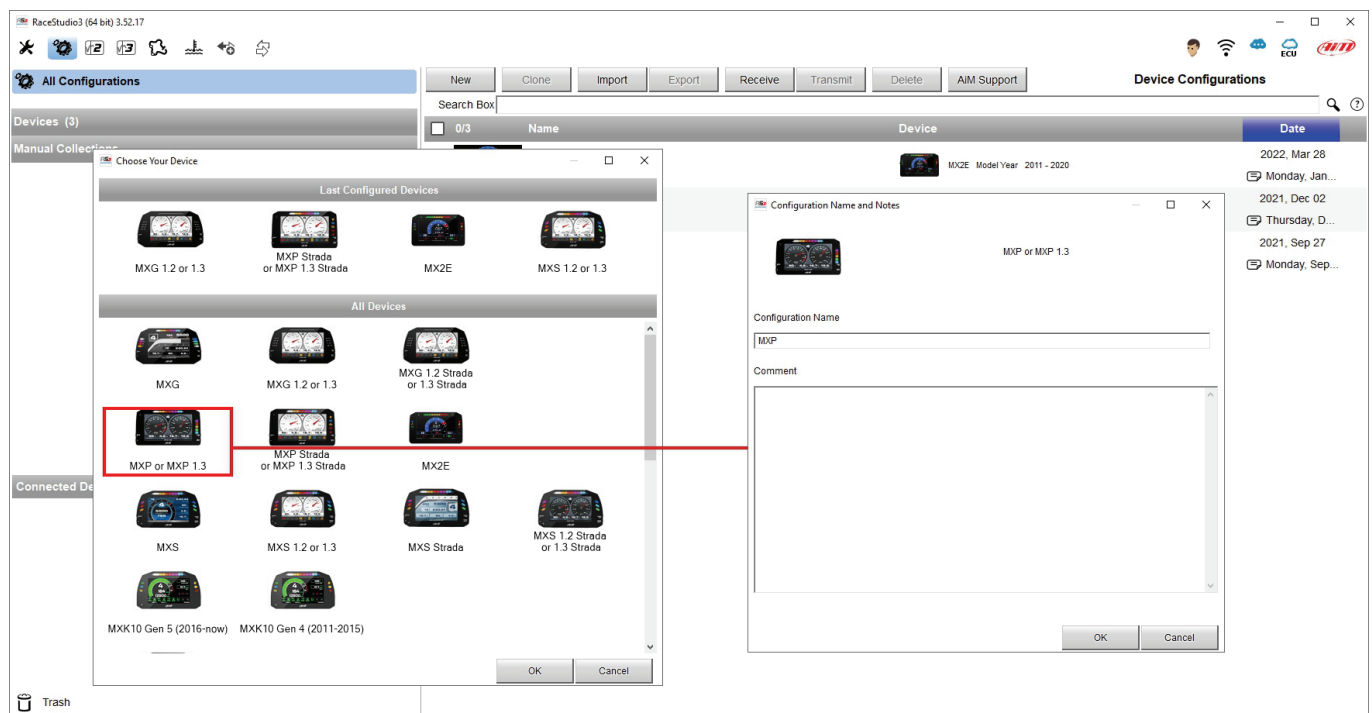

This is the list of the features to be configured:

- Channels: analog and digital sensors directly connected to MX Series loggers.
- ECU: the Engine Control Unit of your vehicle. MX Series logger manages CAN, RS232 and K-Line protocols
- CAN2: in case the system is connected to other CAN devices, beside the ECU, they have to be connected to CAN 2 port
- CAN expansions: other AiM CAN Devices, like, for example, TC Hub (necessary to connect MX1.3 to thermocouple sensors), Lambda controller, GPS Module, Channel expansions etc.
- Math channels: some calculated channels that may be helpful in some situations
- Some other calculated variables, useful for managing alarms, icons, LEDs.

6.2.1 – Channels configuration

To set all the device channels.

RPM channel is by default enabled since direct RPM connection is used when the vehicle does not have an ECU; the software automatically disables it when an ECU protocol is selected. See paragraph 6.2.3 for further information about the hardware RPM signal connection.

Please note: channels connected to the inertial platform are disabled by default because not supported by MX1.3 loggers. If you have a previous logger please enable them.

ID	<input checked="" type="checkbox"/>	Name	Function	Sensor	Unit	Freq	Parameters
RPM	<input checked="" type="checkbox"/>	RPM	Engine RPM	RPM Sensor	rpm	20 Hz	max: 16000 ; factor: 1 ;
Spd1	<input type="checkbox"/>	Speed1	Vehicle Spd	Speed Sensor	kmh 0.1	20 Hz	wheel: 1600 ; pulses: 1 ;
Spd2	<input type="checkbox"/>	Speed2	Vehicle Spd	Speed Sensor	kmh 0.1	20 Hz	wheel: 1600 ; pulses: 1 ;
Spd3	<input type="checkbox"/>	Speed3	Vehicle Spd	Speed Sensor	kmh 0.1	20 Hz	wheel: 1600 ; pulses: 1 ;
Spd4	<input type="checkbox"/>	Speed4	Vehicle Spd	Speed Sensor	kmh 0.1	20 Hz	wheel: 1600 ; pulses: 1 ;
Ch01	<input checked="" type="checkbox"/>	Channel01	Voltage	Generic 0-5 V	mV	20 Hz	
Ch02	<input checked="" type="checkbox"/>	Channel02	Voltage	Generic 0-5 V	mV	20 Hz	
Ch03	<input checked="" type="checkbox"/>	Channel03	Voltage	Generic 0-5 V	mV	20 Hz	
Ch04	<input checked="" type="checkbox"/>	Channel04	Voltage	Generic 0-5 V	mV	20 Hz	
Ch05	<input checked="" type="checkbox"/>	Channel05	Voltage	Generic 0-5 V	mV	20 Hz	
Ch06	<input checked="" type="checkbox"/>	Channel06	Voltage	Generic 0-5 V	mV	20 Hz	
Ch07	<input checked="" type="checkbox"/>	Channel07	Voltage	Generic 0-5 V	mV	20 Hz	
Ch08	<input checked="" type="checkbox"/>	Channel08	Voltage	Generic 0-5 V	mV	20 Hz	
Acc1	<input type="checkbox"/>	InlineAcc	Inline Accel	Internal Accelerometer	g 0.01	50 Hz	
Acc2	<input type="checkbox"/>	LateralAcc	Lateral Accel	Internal Accelerometer	g 0.01	50 Hz	
Acc3	<input type="checkbox"/>	VerticalAcc	Vertical Accel	Internal Accelerometer	g 0.01	50 Hz	
Gyr1	<input type="checkbox"/>	RollRate	Roll Rate	Internal Gyro	deg/s 0.1	50 Hz	
Gyr2	<input type="checkbox"/>	PitchRate	Pitch Rate	Internal Gyro	deg/s 0.1	50 Hz	
Gyr3	<input type="checkbox"/>	YawRate	Yaw Rate	Internal Gyro	deg/s 0.1	50 Hz	
PAccu	<input checked="" type="checkbox"/>	GPS PosAccuracy	GPS Accuracy	GPS	m 0.01	10 Hz	
Spd	<input checked="" type="checkbox"/>	GPS Speed	Vehicle Spd	GPS	kmh 0.1	10 Hz	
Alt	<input checked="" type="checkbox"/>	Altitude	Altitude	GPS	m	10 Hz	
OdD	<input checked="" type="checkbox"/>	Odometer	Odometer Total	Odometer	km 0.1	1 Hz	
Luma	<input checked="" type="checkbox"/>	Luminosity	Brightness	Luminosity	%	1 Hz	
Fuel	<input type="checkbox"/>	FuelUsed	Fuel Level	Fuel Used	l 0.1	10 Hz	
Tlog	<input checked="" type="checkbox"/>	LoggerTemp	Temperature	Logger Temperature	C	1 Hz	

To set a channel just click on its line and the related panel shows up.

The first channels in the list are RPM and Speed, then we have the configurable channels, that can be managed as analog or as digital according to the sensor you connect.

Typically, analog sensors are pressure sensors, thermocouples (**MX1.2 only**), potentiometers etc... while digital inputs are used for managing pushbuttons that activate Digital outputs.

Selecting “**Analog**” options to be set are

- Channel name
- Function: this parameter is useful in the data analysis process
- Sensor type
- Measure unit
- Sampling frequency
- Display precision: it configures how many decimal digits you will see in your dash
- Specific parameters

In the following image you see two different channels configuration windows.

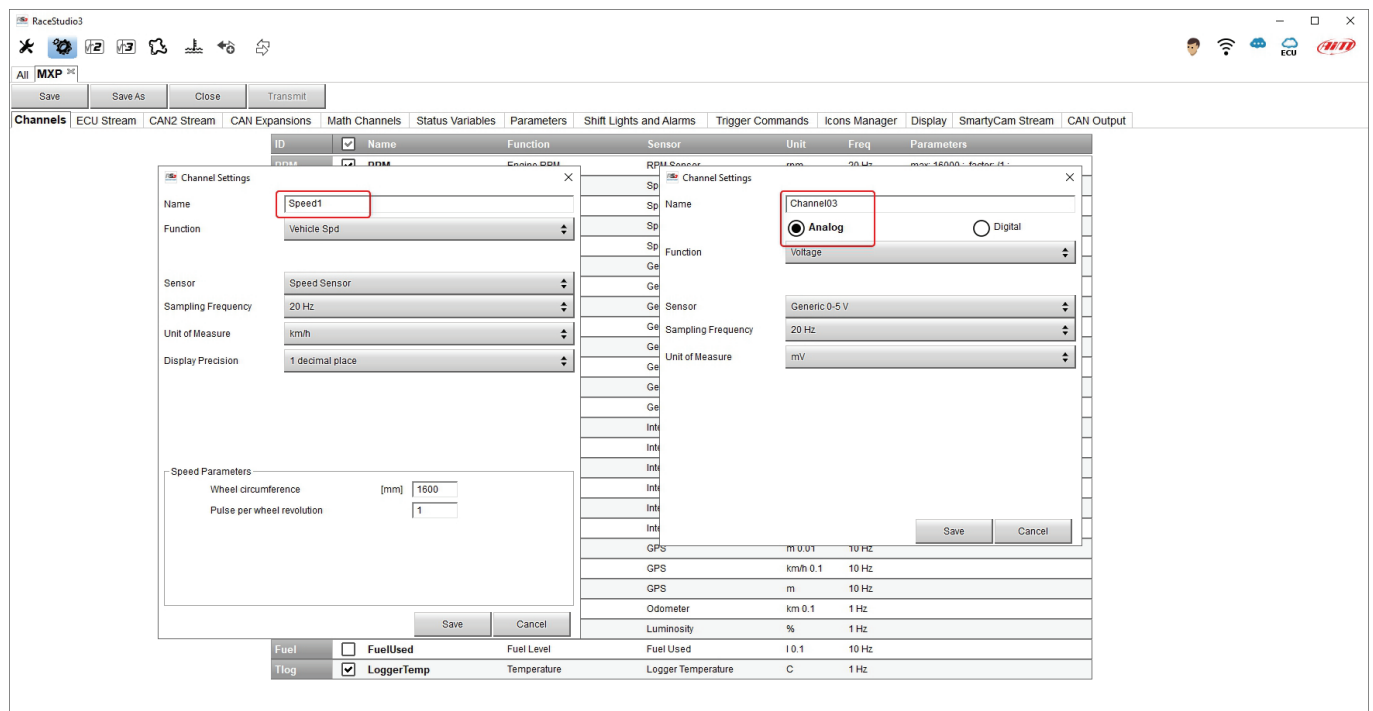

In case you need to use an input as **Digital Input** you have to configure its parameters as explained in the following pages. Pressing the red "i" icon on the setting panel a datasheet explaining digital input working mode can be downloaded. The document is only available in English.

Please note: if **Logged** checkbox is flagged the system records the channel, else it can be used and shown but not recorded.

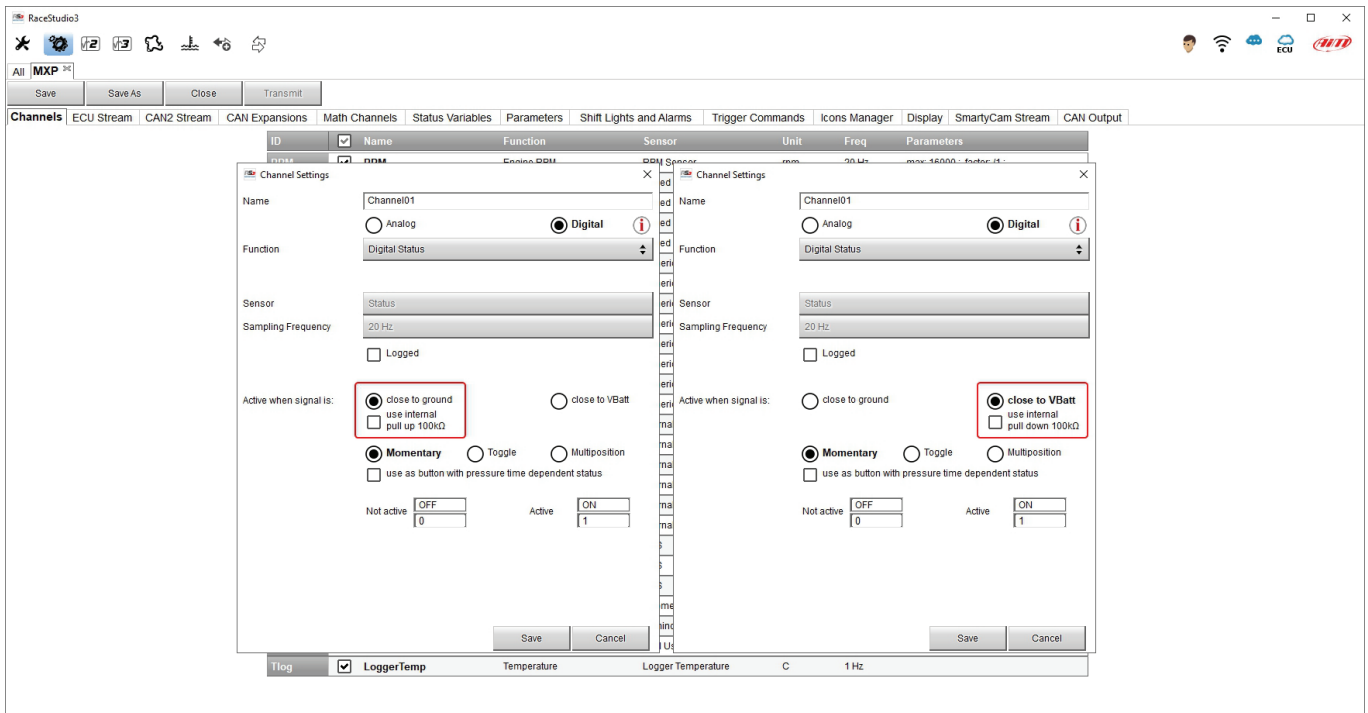

- **Working mode:** a Digital input can work in two different ways:
 - The pushbutton closes to ground (with or without pull up resistor – left image below)
 - The pushbutton closes to VBattery (with or without pull down resistor – right image below)

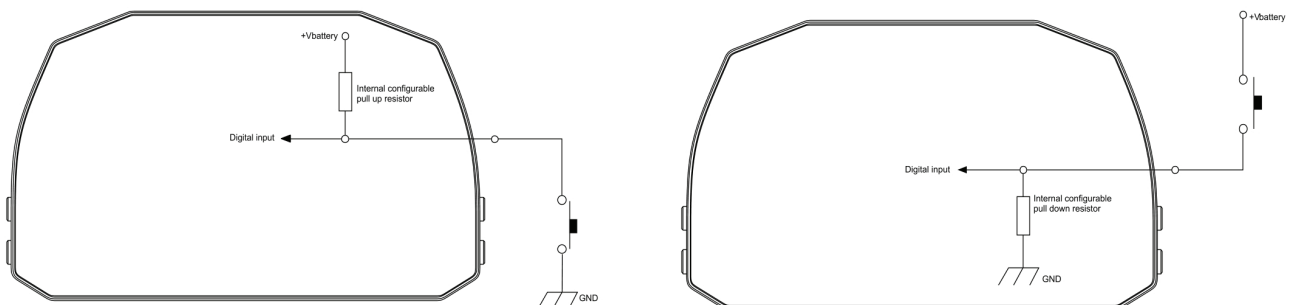

- Active/Not active labels:** according to the status, a Digital channel may assume the values: 0/1, High/Low, ON/OFF, Closed/Open, True/False, etc; max number of characters for the label is 5.
 The two different labels can be defined and eventually shown on the display, used by Math channels, Icons Management, alarm managements and in general, any time a digital channel is required; the labels appears in Device page too.
- Signal can be momentary, toggle or multiposition, to say
 - Momentary:** the channel is active when the pushbutton is pressed
 - Toggle:** the channel is activated the first time button is pressed and deactivated the second time the button is pressed
 - Multiposition:** the channel can take different status according to the number of pressures and it is possible to add status using the "+" button that appears right of the panel once "Multiposition" option is been selected.
 - Use as button with pressure time dependent status:** it is possible to configure pressure time so that once the threshold value is reached the pressure switches from short to long and the channel from one status to the other. The image here below shows its working mode.

MOMENTARY

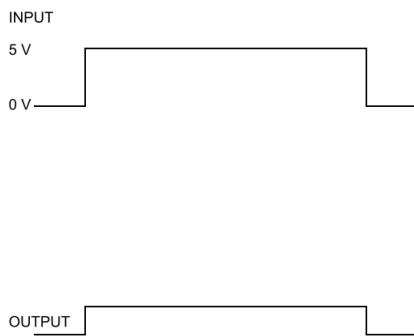

MOMENTARY WITH TIME THRESHOLD

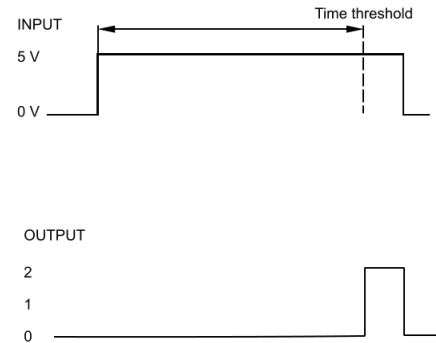
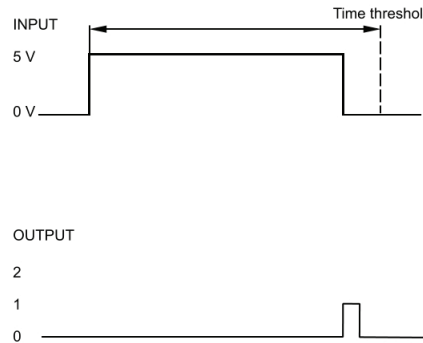

TOGGLE

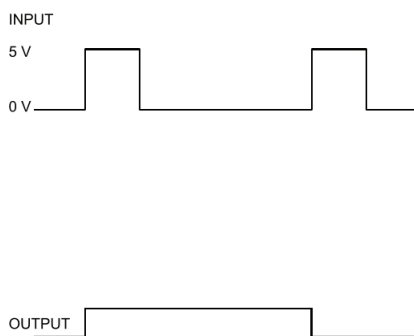

TOGGLE WITH TIME THRESHOLD

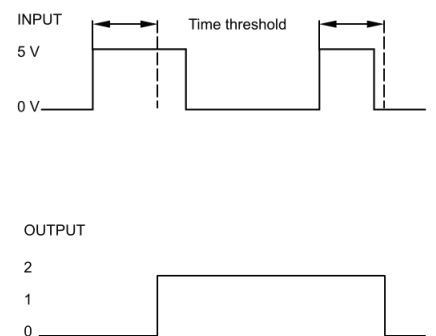
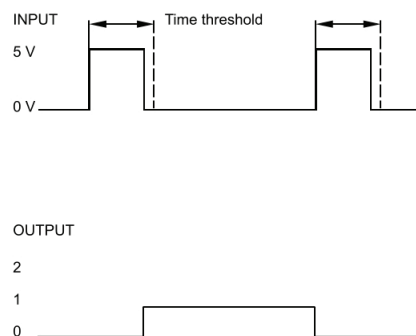

6.2.2 – ECU Connection and configuration

MX Series can be connected to the vehicle ECU. Documents explaining how to connect MX Series to the vehicle ECU are published on our website www.aim-sportline.com and a PDF file with protocols updates history can be loaded clicking on the question mark as shown here below. MX Series can communicate through CAN, RS232 and K-Line communication lines.

The ECU protocol includes more than 1500 different protocols and is constantly updated by our technicians. In case of a CAN based ECU whose protocol is not in the database, the ECU Driver Builder function (paragraph 6.4) allows to develop it.

To load the ECU protocol in MX Series configuration:

- enter “ECU Stream” tab
- at the very first configuration panel showing all supported ECU shows up; afterwards press “Change ECU” button
- select “ECU Manufacturer” and “ECU Model” (in the example FORD/ MUSTANG 2010)
- press OK

Click “ECU” icon to know the ECU Protocol Updates History.

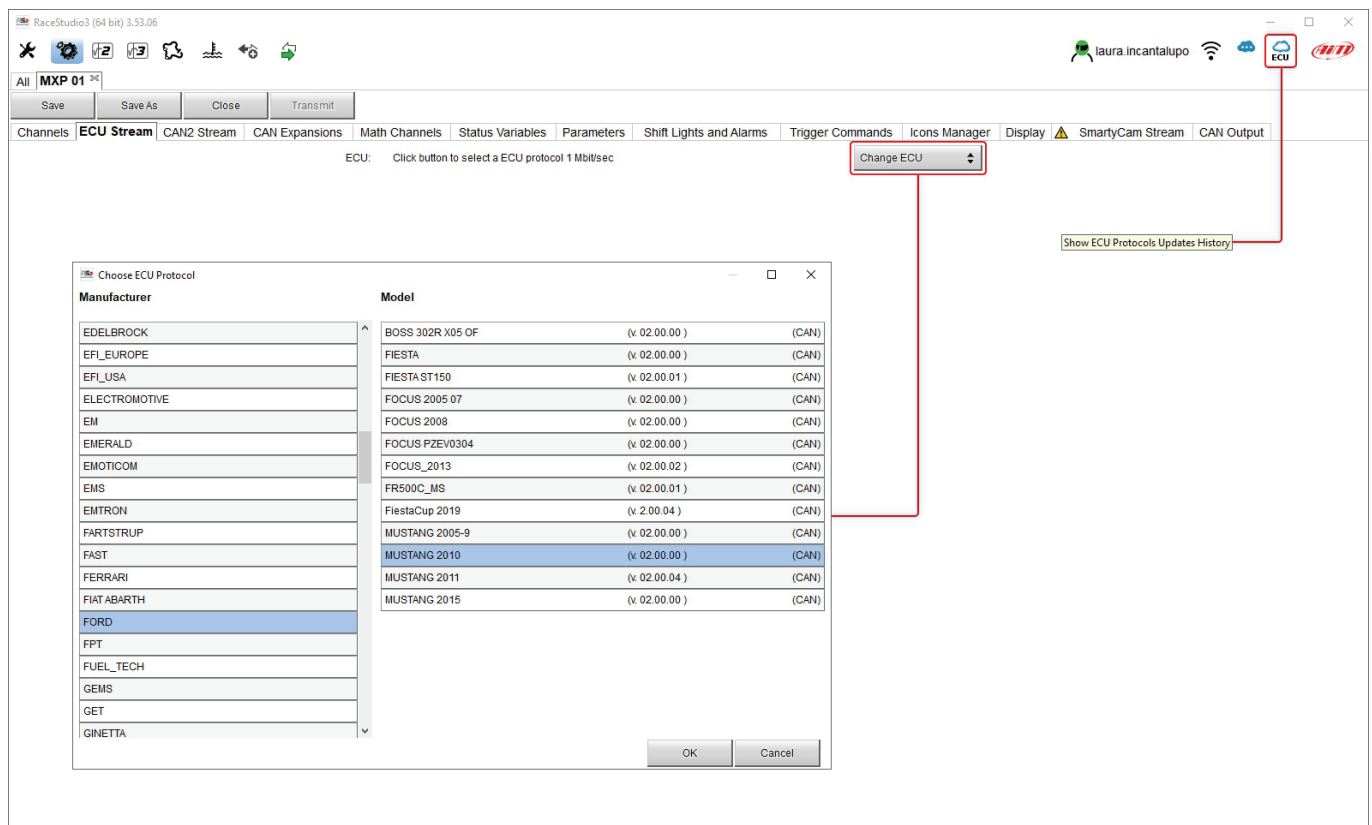

After setting the protocol the system comes back to “ECU Stream” page and two checkbox appears:

- “Enable the CAN Bus 120 Ohm Resistor” (enabled by default; to be disabled in case MX Series logger is additional to the vehicle dash): the CAN Bus needs two 120 Ohm resistors at its two extremes. In case MX Series is the only device connected to the ECU the 120 Ohm resistor should be enabled, else, very easily, it is already present in the existing network and should be disabled;
- “silent on CAN Bus” (disabled by default): usually the ECU expects an acknowledge signal when transmits a message and, as default, the MX Series transmits this signal. Sometimes, particularly when there are other devices in the network, MX Series should not transmit it; in this case, enabling this flag MX Series logger remains completely silent.

ECU: FORD - MUSTANG 2010 (ver. 02.00.00) 500 Kbit/sec

Enable the CAN Bus 120 Ohm Resistor

Silent on CAN Bus

Enabled Channels (Max: 120) 35 / 35

ID	✓	Name	Function	Unit	Freq
CC08	✓	RPM	Engine RPM	rpm	10 Hz
CC09	✓	SpeedVeh	Vehicle Spd	km/h 0.1	10 Hz
CC13	✓	SpeedFL	Wheel Spd	km/h 0.1	10 Hz
CC14	✓	SpeedFR	Wheel Spd	km/h 0.1	10 Hz
CC15	✓	SpeedRL	Wheel Spd	km/h 0.1	10 Hz
CC16	✓	SpeedRR	Wheel Spd	km/h 0.1	10 Hz
CC17	✓	Gear	Gear	gear	10 Hz
CC25	✓	WaterTemp	Water Temp	C 0.1	10 Hz
CC04	✓	TurboBoost	Number	#	10 Hz
CC21	✓	TCSBrakeEvent	Number	#	10 Hz
CC22	✓	TCSEngEvent	Number	#	10 Hz
CC23	✓	StabCtrlTeltal	Number	#	10 Hz
CC24	✓	StabCtrlMTXT	Number	#	10 Hz
CC34	✓	TyreRvMile	Number	#	10 Hz
CC31	✓	FuelLevelMean	Percent	% 0.01	10 Hz
CC32	✓	FuelInst1	Percent	% 0.01	10 Hz
CC33	✓	FuelInst2	Percent	% 0.01	10 Hz
CC35	✓	AxleRatio	Number	#	10 Hz
CC10	✓	PedalPosition	Percent	% 0.01	10 Hz
CC01	✓	YawRate	Yaw Rate	deg/s 0.1	10 Hz
CC02	✓	LateralAcc	Lateral Accel	g 0.01	10 Hz
CC03	✓	SWAngle	Steering Pos	deg 0.1	10 Hz
CC05	✓	TrqAct	Torque	Nm 0.1	10 Hz
CC06	✓	TrqSource	Number	#	10 Hz
CC07	✓	BrakeLampSw	Number	#	10 Hz

6.2.3 – RPM

MX Series can receive RPM value from the ECU. If, on the contrary, the vehicle does not have an ECU RPM can be sampled using the wire labelled “RPM” (corresponding to pin 15) of MX Series 37 pins connector harness.

RPM from ECU

To get the RPM from the ECU just connect MX Series logger to the ECU and it will automatically sample that value.

RPM via a 5-50V square wave or coil (150-400V)

If the vehicle has no ECU connect wire labelled “RPM” (corresponding to pin 15) of the device 37 pins connector harness to the ignition system. This way MX Series can read the signal from the low voltage of the coil (whose peak can be from 150 to 400 V) or from a possible square wave (the peak can be from 5 to 50 V).

The image below shows an example of wiring of the ignition system.

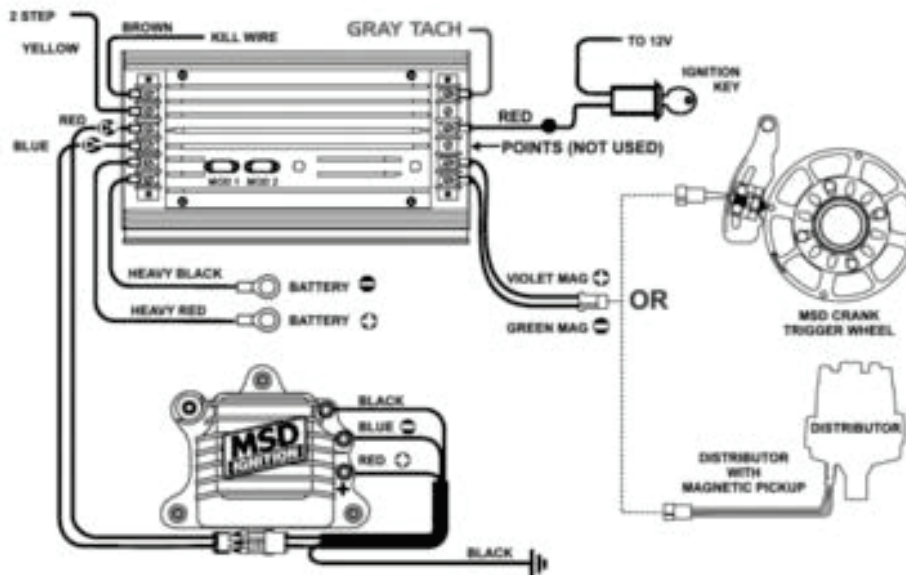

The output labelled “GRAY TACH” gives a 5-50V output that can be directly sampled by MX Series logger.

In case the vehicle ignition system has no output MX Series logger should be connected to the low voltage of the coil as shown in the following images.

Point 1: low voltage of the coil

Point 2: connected to the spark plug

Point 3: connected to the +12V of the battery

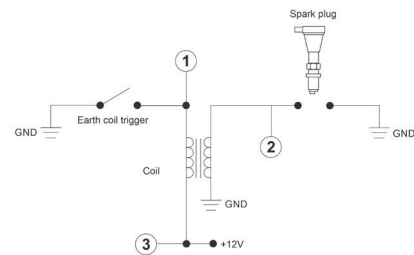
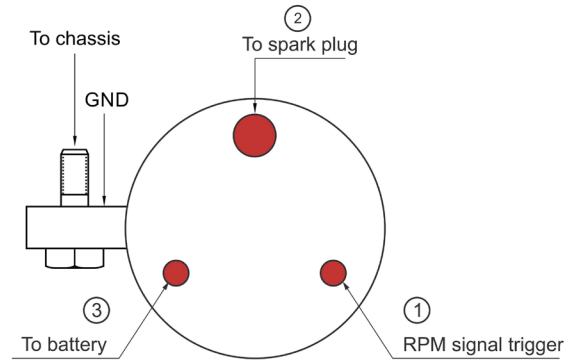



Once MX Series connected to RPM signal enable it and set its parameters in channels page of Race Studio 3 as explained in “Channels configuration” paragraph.

The screenshot shows the RaceStudio3 interface with the Channels page active. A table lists various channels, and a dialog box is open for configuring the RPM channel. The dialog box has three sections: Channel Settings, Sensor, and RPM Parameters.

ID	Name	Function	Sensor	Unit	Freq	Parameters
RPM	<input type="checkbox"/> RPM	Engine RPM	RPM Sensor	rpm	20 Hz	max: 16000; factor: /1;
Spd1	<input type="checkbox"/> Speed1	Vehicle Spd	Speed Sensor	km/h 0.1	20 Hz	wheel: 1600; pulses: 1;
Spd2	<input type="checkbox"/> Speed2					wheel: 1600; pulses: 1;
Spd3	<input type="checkbox"/> Speed3					wheel: 1600; pulses: 1;
Spd4	<input type="checkbox"/> Speed4					wheel: 1600; pulses: 1;
Ch01	<input checked="" type="checkbox"/> Channel01					
Ch02	<input checked="" type="checkbox"/> Channel02					
Ch03	<input checked="" type="checkbox"/> Channel03					
Ch04	<input checked="" type="checkbox"/> Channel04					
Ch05	<input checked="" type="checkbox"/> Channel05					
Ch06	<input checked="" type="checkbox"/> Channel06					
Ch07	<input checked="" type="checkbox"/> Channel07					
Ch08	<input checked="" type="checkbox"/> Channel08					
Acc1	<input type="checkbox"/> InlineAcc					
Acc2	<input type="checkbox"/> LateralAcc					
Acc3	<input type="checkbox"/> VerticalAcc					
Gyr1	<input type="checkbox"/> RollRate					
Gyr2	<input type="checkbox"/> PitchRate					
Gyr3	<input type="checkbox"/> YawRate					
PAccu	<input checked="" type="checkbox"/> GPS PosAccuracy					
Spd	<input checked="" type="checkbox"/> GPS Speed	Vehicle Spd	GPS	km/h 0.1	10 Hz	
Alt	<input checked="" type="checkbox"/> Altitude	Altitude	GPS	m	10 Hz	
OdD	<input checked="" type="checkbox"/> Odometer	Odometer Total	Odometer	km 0.1	1 Hz	
Luma	<input checked="" type="checkbox"/> Luminosity	Brightness	Luminosity	%	1 Hz	
Fuel	<input type="checkbox"/> FuelUsed	Fuel Level	Fuel Used	l 0.1	10 Hz	
Tlog	<input checked="" type="checkbox"/> LoggerTemp	Temperature	Logger Temperature	C	1 Hz	

Channel Settings

Name: RPM

Function: Engine RPM

Sensor

Sensor: RPM Sensor

Sampling Frequency: 20 Hz

RPM Parameters

RPM Max: 16000

RPM Factor: /1

Buttons: Save, Cancel

6.2.4 – CAN2 Stream configuration

This page works exactly like ECU Stream one. Here you can find additional CAN modules. To load additional CAN protocol modules:

- enter “CAN2 Stream” tab
- at the very first configuration a panel showing all supported non AiM external modules shows up; afterwards press “Change protocol” button
- select “Manufacturer” and “Model” (in the example MEGALINE/PADDLESHIFT)
- press OK

As for ECU Stream a PDF file with protocols updates history can be loaded clicking on the question mark as shown here below and the two checkbox appears as explained before.

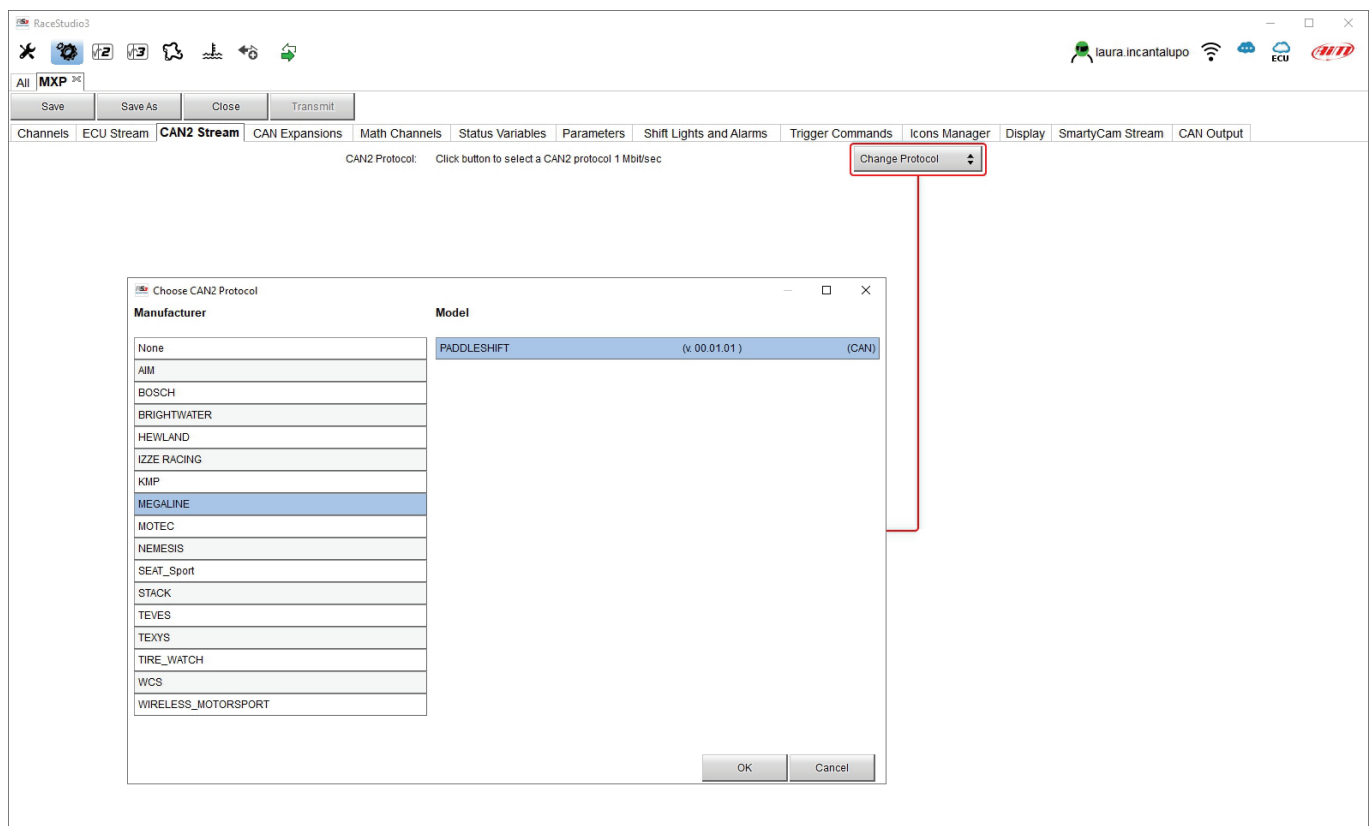

6.2.5 – CAN Expansions configuration

MX Series can be connected to various AiM CAN expansions:

- LCU-One CAN
- Channel Expansions
- TC Hub (**necessary to connect thermocouple sensors to MX1.3 loggers**)
- RIO_02a
- Shift Light Module
- Steering wheel3
- GS Dash

At the very first MX Series connection this page shows up:

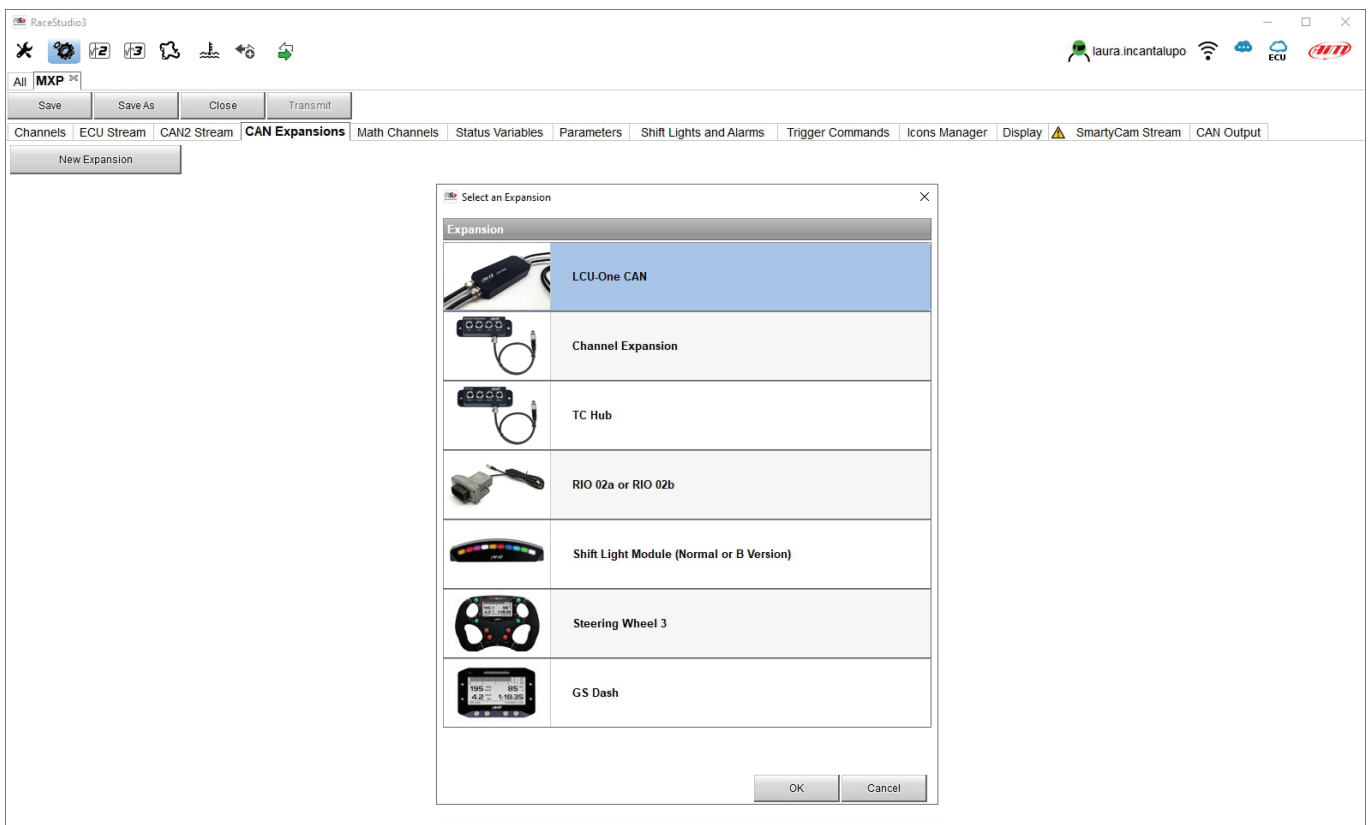

Select the CAN expansion to set and press "OK". Each expansion needs to be set filling in the related panel.

Setting LCU-One CAN

To set an LCU-One CAN:

- press “New Expansion” button;
- select “LCU-One CAN” and press OK
- name the LCU One and fill in its serial number or press “Get SN from a connected expansion” to receive the serial number from the connected LCU-One
- select the multiplier to calculate AFR from lambda (in the example “14.57 Gasoline”) or add a custom value pressing “Add Custom Value” (the related panel shows up)
- set the LCU One channels double clicking on each channel and setting the panel that shows up
- press “Close” to save and exit

Expansion Name (6 Characters Max.)

Expansion Serial Number (S.N.)

Multiplier to calculate AFR (AF) from lambda (AFR = Air Fuel Ratio = pounds of air / pound of fuel)

14.57 - Gasoline

Multiplier Lambda Values	New Value	Label for New Value
6.40 - Methanol	14.57	Gasoline
9.00 - Ethanol		
14.57 - Gasoline		
14.60 - Diesel		
15.50 - LPG (Propane)		
17.20 - CNG		

ID	Name	Function	Sensor	Unit	Freq
Lmd	<input checked="" type="checkbox"/> 0Lambda	Lambda	LCU-One Lambda	lambda 0.01	10 Hz
AFR	<input checked="" type="checkbox"/> 0AFR	AFR	LCU-One AFR	AF 0.01	10 Hz
LTrm	<input checked="" type="checkbox"/> 0LmdTmp	Lambda Temp	LCU-One Temp	C 0.1	10 Hz
LDg	<input checked="" type="checkbox"/> 0Diagn	Lambda Diagn	LCU-One Diagn	#	1 Hz

Please note: for any further information about AiM LCU-One CAN refer to the related user manual you find in the box or you can download from AiM website www.aim-sportline.com documentation area, products section.

Setting Channel Expansion

To set a Channel Expansion:

- press “New Expansion” button;
- select “Channel Expansion” and press OK
- name the Channel expansion and fill in its serial number or press “Get SN from a connected expansion” to receive the serial number from the connected Channel Expansion
- set each channel double clicking on each channel and setting the panel that shows up (it works exactly like channels configuration – see the related paragraph)
- press “Close” to save and exit

The screenshot shows the RaceStudio3 interface with the 'CAN Expansions' tab selected. A 'New Expansion' dialog box is open, showing a table of channels and a 'Channel Settings' dialog box for '0Channel01'.

ID	✓	Name	Function	Sensor	Unit	Freq
C01	✓	0Channel01	Voltage	Generic 0-5 V	mV	20 Hz
C02	✓	0Channel02	Voltage	Generic 0-5 V	mV	20 Hz
C03	✓	0Channel03	Voltage	Generic 0-5 V	mV	20 Hz
C04	✓	0Channel04	Voltage	Generic 0-5 V	mV	20 Hz

The 'Channel Settings' dialog box for '0Channel01' shows the following configuration:

- Name: 0Channel01
- Function: Voltage
- Sensor: Generic 0-5 V
- Sampling Frequency: 20 Hz
- Unit of Measure: mV

Please note: for any further information about AiM Channel expansion refer to the related user manual you find in the box or you can download from AiM website www.aim-sportline.com documentation area, products section.

Setting TC Hub.

This CAN expansion **only supports K type thermo-couples and is necessary to connect thermocouple sensor to MX1.3 loggers**
 To set a TC Hub:

- press “New Expansion” button;
- select “TC Hub” and press OK
- name the TC Hub expansion and fill in its serial number or press “Get SN from a connected expansion” to receive the serial number from the connected TC Hub
- for each channel set sampling frequency, measure unit and display precision
- press “Close” to save and exit

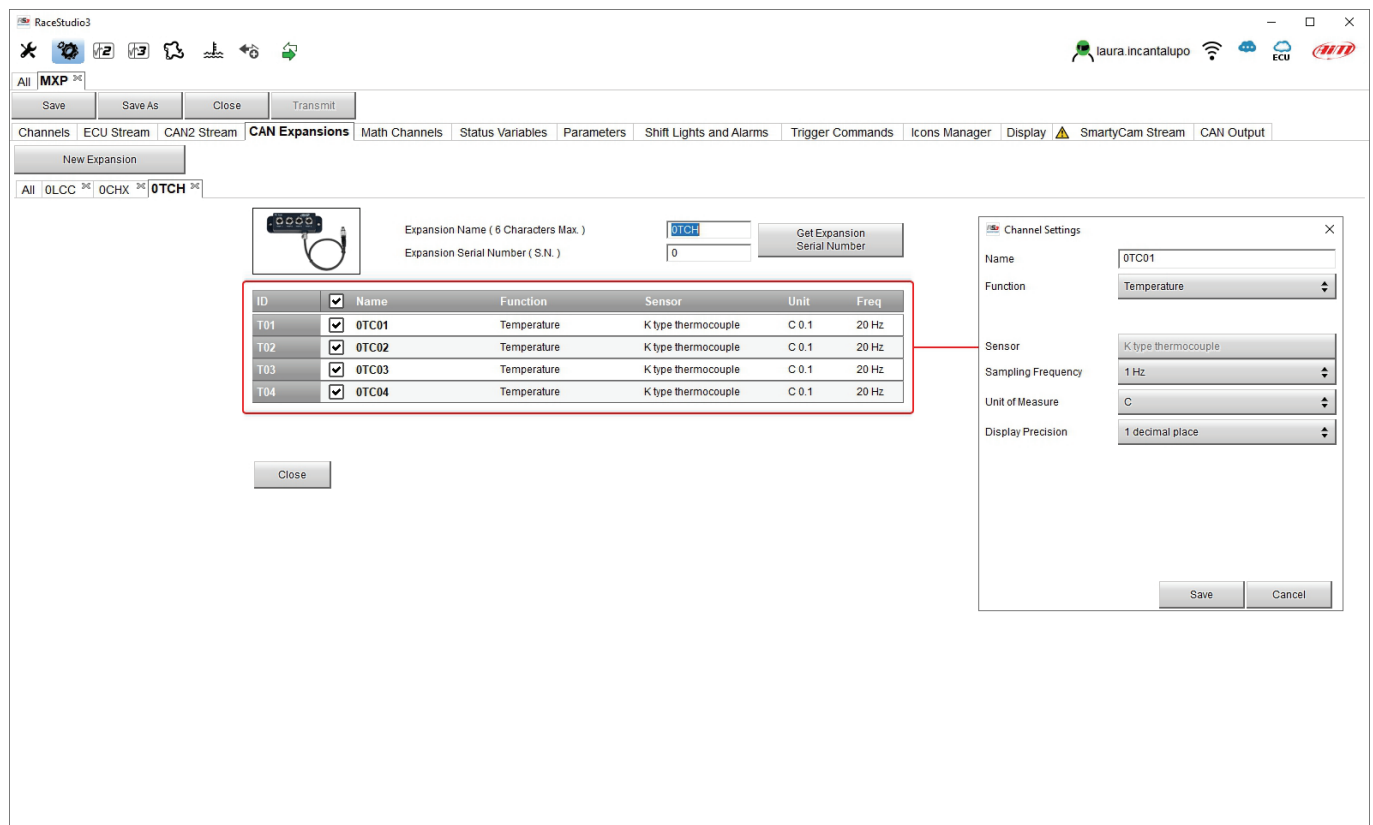

Please note: for any further information about AiM TC Hub refer to the related user manual you find in the box or you can download from AiM website www.aim-sportline.com documentation area, products section.

Setting RIO_2a.

This CAN expansion allows to manage external switches.

To set a RIO_2a:

- press "New Expansion" button;
- select "RIO_02a" and press OK
- name the RIO_02a and fill in its serial number or press "Get SN from a connected expansion" to receive the serial number from the connected RIO_02
- RIO_02a channels work exactly as all MX series channels; please refer to paragraph 6.2.1 to set the channels
- press "Close" to save and exit

The screenshot shows the RaceStudio3 interface. At the top, there's a menu bar with options like Channels, ECU Stream, CAN2 Stream, and CAN Expansions. Below the menu, there's a 'New Expansion' button. The main area shows a list of channels for the 'R2a' expansion. A table lists 19 channels, each with a checkbox, name, function, sensor, unit, and frequency. A 'Channel Settings' dialog box is open, showing configuration options for 'R2a Channel06'.

ID	Name	Function	Sensor	Unit	Freq
Ch01	<input checked="" type="checkbox"/> R2a Channel01	Digital Status	Status		20 Hz
Ch02	<input checked="" type="checkbox"/> R2a Channel02	Digital Status	Status		20 Hz
Ch03	<input checked="" type="checkbox"/> R2a Channel03	Digital Status	Status		20 Hz
Ch04	<input checked="" type="checkbox"/> R2a Channel04	Digital Status	Status		20 Hz
Ch05	<input checked="" type="checkbox"/> R2a Channel05	Digital Status	Status		20 Hz
Ch06	<input checked="" type="checkbox"/> R2a Channel06	Digital Status	Status		20 Hz
Ch07	<input checked="" type="checkbox"/> R2a Channel07	Digital Status	Status		20 Hz
Ch08	<input checked="" type="checkbox"/> R2a Channel08	Digital Status	Status		20 Hz
Ch09	<input checked="" type="checkbox"/> R2a Channel09	Digital Status	Status		20 Hz
Ch10	<input checked="" type="checkbox"/> R2a Channel10	Digital Status	Status		20 Hz
Ch11	<input checked="" type="checkbox"/> R2a Channel11	Digital Status	Status		20 Hz
Ch12	<input checked="" type="checkbox"/> R2a Channel12	Digital Status	Status		20 Hz
Ch13	<input checked="" type="checkbox"/> R2a Channel13	Digital Status	Status		20 Hz
Ch14	<input checked="" type="checkbox"/> R2a Channel14	Digital Status	Status		20 Hz
Ch15	<input checked="" type="checkbox"/> R2a Channel15	Digital Status	Status		20 Hz
Ch16	<input checked="" type="checkbox"/> R2a Channel16	Digital Status	Status		20 Hz
Ch17	<input checked="" type="checkbox"/> R2a Channel17	Digital Status	Status		20 Hz
Ch18	<input checked="" type="checkbox"/> R2a Channel18	Digital Status	Status		20 Hz
Ch19	<input checked="" type="checkbox"/> R2a Channel19	Digital Status	Status		20 Hz

Channel Settings Dialog:

- Name: R2a Channel06
- Function: Digital Status
- Sensor: Status
- Sampling Frequency: 20 Hz
- Logged
- Active when signal is:
 - close to ground
 - close to VBatt
 - Momentary
 - Toggle
 - Multiposition
- use as button with pressure time dependent status
 - Threshold for short/long pressure time (sec): 0.5
- Rest label: OFF [0]
- Short time label: SHORT [1]
- Long time label: LONG [2]

To set a new output:

- fill in output name (1)
- choose channel, working mode and specify if all condition are to be satisfied or only one of them (2-4)
- decide if the circuit is to be open or closed (5)
- decide ending condition ("Untill" – 6) among "condition no longer met", "the device is turned off", "a button is pushed" "data are downloaded"
- "+" buttons right of the panel are to add a new condition (top one) or a new output (bottom one)
- once all operations performed press "Save" in "Create New Alarm" panel.

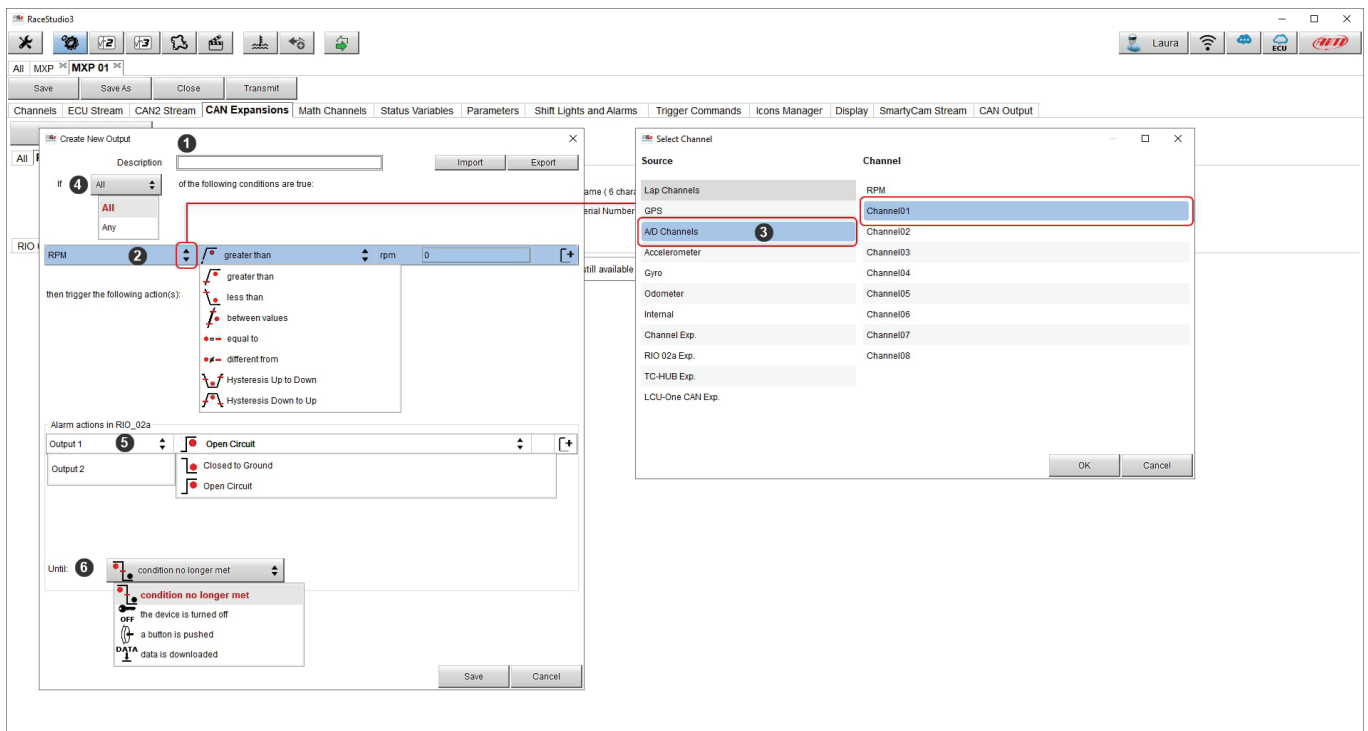

The screenshot displays the 'Create New Output' dialog in RaceStudio3. The dialog is titled 'Create New Output' and contains the following elements:

- Description (1):** A text field for the output name, currently empty.
- Conditions (2-4):** A section titled 'If' with a dropdown menu set to 'All'. Below it, a list of conditions is shown, with 'greater than' selected for the variable 'rpm' and a value of '0'.
- Alarm actions (5):** A section titled 'then trigger the following action(s):' with a list of actions. 'Open Circuit' is selected for 'Output 1'.
- Until (6):** A section titled 'Until' with a dropdown menu set to 'condition no longer met'.
- Select Channel Dialog:** A separate dialog box titled 'Select Channel' is open on the right. It has a 'Source' dropdown set to 'RPM' and a list of channels. 'Channel01' is selected and highlighted.

Setting Shift Lights Module.

This CAN expansion works exactly as MX series Shift Lights and can be placed in a position more comfortable than the shift lights for the racer.

To set Shift Light Module:

- press "New Expansion"
- select "Shift Light Module" and press OK
- the module works exactly like MX series shift lights so available options are:
 - use for predictive time
 - use as gear shift lights
- set it as explained in paragraph 6.2.9 and press "SAVE"

The screenshot shows the RaceStudio3 software interface. The main window is titled "RaceStudio3" and contains a toolbar with various icons. Below the toolbar is a menu bar with options: "All", "MXP", "Save As", "Close", and "Transmit". A "New Expansion" button is visible. The "CAN Expansions" tab is selected, showing a table of gear settings. The table has columns for "Gear", "Shift Light 1", "2", "3", "4", "5", "6", "7", "8", "9", and "10". The "Shift Light 1" column contains values: 8200, 8400, 8600, 8800, 9000, 9200, 9400, 9600, 9800, 10000. The "2" through "10" columns contain colored circles representing light states. Below the table is a checkbox labeled "Activate Simulation". At the bottom of the window is a 3D model of the shift light module, which is a black, curved device with ten colored lights (green, yellow, red) and the AIM logo.

Gear	Shift Light 1	2	3	4	5	6	7	8	9	10
All	8200	8400	8600	8800	9000	9200	9400	9600	9800	10000

Setting Steering Wheel 3 or GS Dash

Steering Wheel and GS Dash are configured in the same way but you can install only one of them

- press "New Expansion";
- select "Formula Steering Wheel 3" and press OK
- the panel here below shows up: select the preferred page layout and press "OK" or double click on the desired layout.

The screenshot shows the RaceStudio3 software interface. A dialog box titled "Select a page to add" is open, displaying a grid of dashboard widget options. The options are arranged in a grid with labels P1 through P16. A red box highlights the P4 widget, which displays a battery voltage of 12.5V, a battery level of 85%, a fuel pressure of 4.2 bar, and a fuel pressure of 0.9 bar. Other widgets include speedometer (195 km/h), tachometer (5500 RPM), oil pressure (0.9 bar), and various other gauges and bargraphs. The interface also shows a menu bar with options like "Channels", "ECU Stream", "CAN2 Stream", "CAN Expansions", "Math Channels", "Status Variables", "Parameters", "Shift Lights and Alarms", "Trigger Commands", "Icons Manager", "Display", "SmartyCam Stream", and "CAN Output". A "New Expansion" button is visible in the top left of the main window.

The module allows to configure both display page and shift lights and alarms and works exactly like them (paragraphs 6.2.12 and 6.2.9) and is to be configured in the same way.

To configure the **display**

- select the display area where to place the desired channel or the not set row (1)
- choose the group of channels and then the channel to show (2-3) and double click on it to place it in the desired area (4)
- the row becomes configured (5)
- repeat the operation for all the display areas and press "SAVE"

The screenshot shows the RaceStudio3 interface with the 'Display' tab selected. The main workspace is divided into several sections:

- Page 1:** A large display area containing a gear indicator showing '5 Gear' (marked with a circled 4) and an 'INFO LINE' section below it.
- Channel Groups:** A list on the right side of the workspace, with 'ECU' selected (marked with a circled 2).
- Channels:** A list of channels under the 'ECU' group, with 'Gear' selected (marked with a circled 3).
- Configuration Row:** At the bottom of the workspace, a row is being configured. The 'Gear' channel is selected in the first column (marked with a circled 5), and the 'gear' channel is selected in the second column (marked with a circled 1).

The interface also includes a top toolbar with various icons, a menu bar with options like 'Save', 'Save As', 'Close', and 'Transmit', and a status bar at the bottom.



Shift lights can be set as gear shift lights or for predictive time and it is possible to add new alarms. Please refer to paragraph 6.2.9 to know how to configure shift lights and alarms.

The screenshot shows the RaceStudio3 software interface. At the top, there is a menu bar with options like Channels, ECU Stream, CAN2 Stream, CAN Expansions, Math Channels, Status Variables, Parameters, Shift Lights and Alarms, Trigger Commands, Icons Manager, Display, SmartyCam Stream, and CAN Output. The 'Shift Lights and Alarms' menu is currently selected.

Below the menu, there are two radio buttons: 'Use for predictive time' (unselected) and 'Use as gear shift lights' (selected). Below these is a table for configuring shift lights:

Gear	Shift Light 1	2	3	4	5	6
All	9000	9200	9400	9600	9800	10000

Each cell in the table contains a small colored circle representing the light's state. Below the table is a checkbox for 'Activate Simulation'.

In the center, there is a preview of a digital instrument cluster. The cluster displays: 195 km/h (SPD), 85 WT C (WT), 4.2 bar (OILP), and 1:18:35 (time). It also shows 'GPS: GOOD' and 'THUNDERHILL LONG'.

At the bottom, there is an 'Alarms' section with a table:

priority	Events	Alarms	Output
<input checked="" type="checkbox"/>	Water	LED: 1	

Below the table are buttons for '+ Add New Alarm', 'still available alarms: 35', 'Import Alarm', and 'Export Alarm'.

6.2.6 – Math channels configuration

To create math channels; available options are:

- Bias: considering a relation between two mutually compatible channels it computes which one is prevailing (typically used for suspensions or brakes);
- Bias with threshold: it needs the user to set a threshold value for the considered channels; once these threshold are both exceeded the system makes the calculation;
- Calculated gear: it calculates the gear position using engine RPM and vehicle speed
- Precalculated gear: it calculates the gear position using Load/Shaft ratio for each gear and for the vehicle axle too
- Linear correction: typically used when a channel is not available in the desired format or if it is wrongly tuned and cannot be tuned again
- Simple operation: to add or subtract from a channel value a constant value or another channel value
- Division Integer: to get the integer part of the division
- Division Modulo: to get the remainder part of the division
- Bit composed: to compose 8 flags in a bit-field measure

Each option asks the user to fill in a proper panel. CAMBIARE IMMAGINE

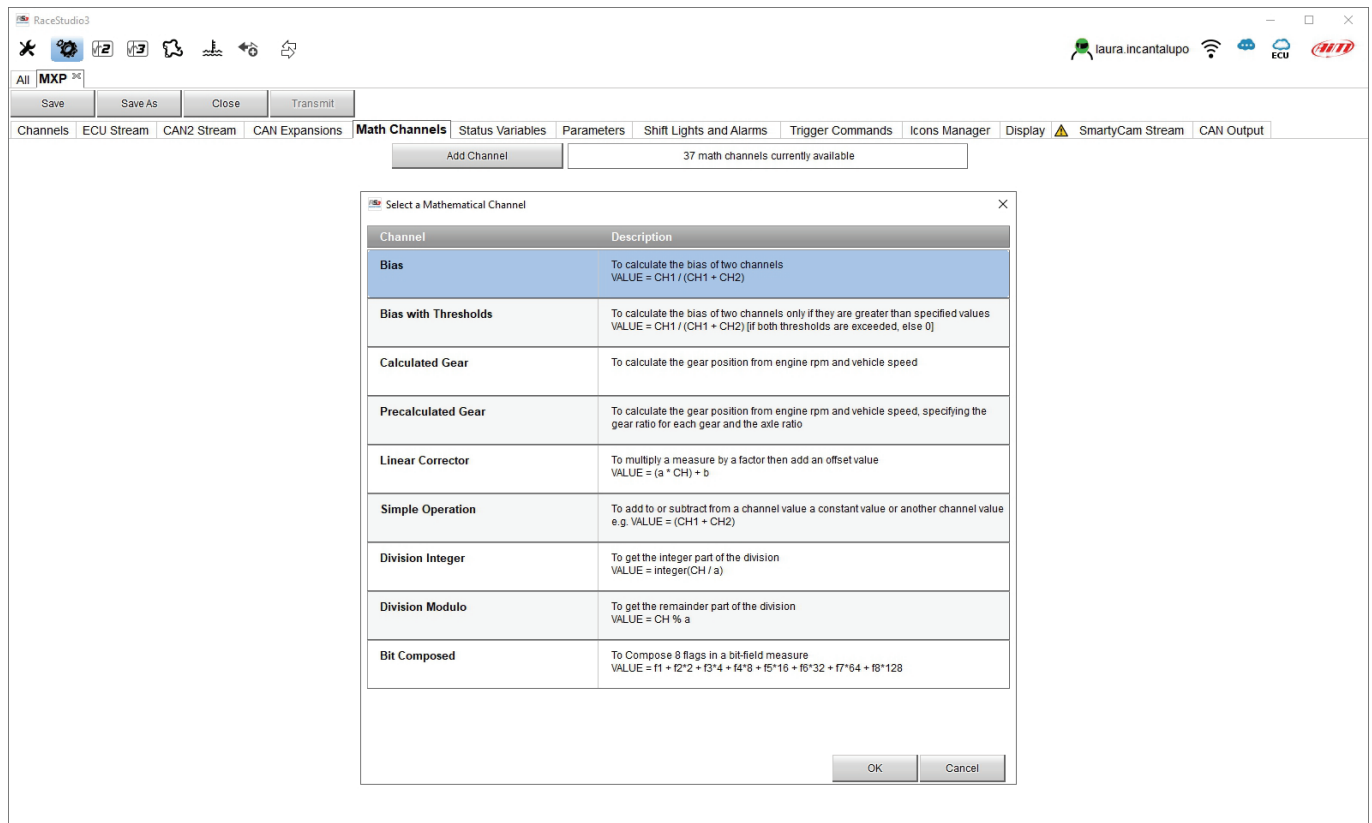

The screenshot shows the RaceStudio3 interface with the 'Math Channels' tab selected. A dialog box titled 'Select a Mathematical Channel' is open, displaying a table of available options:

Channel	Description
Bias	To calculate the bias of two channels VALUE = CH1 / (CH1 + CH2)
Bias with Thresholds	To calculate the bias of two channels only if they are greater than specified values VALUE = CH1 / (CH1 + CH2) (if both thresholds are exceeded, else 0)
Calculated Gear	To calculate the gear position from engine rpm and vehicle speed
Precalculated Gear	To calculate the gear position from engine rpm and vehicle speed, specifying the gear ratio for each gear and the axle ratio
Linear Corrector	To multiply a measure by a factor then add an offset value VALUE = (a * CH) + b
Simple Operation	To add to or subtract from a channel value a constant value or another channel value e.g. VALUE = (CH1 + CH2)
Division Integer	To get the integer part of the division VALUE = integer(CH / a)
Division Modulo	To get the remainder part of the division VALUE = CH % a
Bit Composed	To Compose 8 flags in a bit-field measure VALUE = f1 + f2*2 + f3*4 + f4*8 + f5*16 + f6*32 + f7*64 + f8*128

The dialog box includes 'OK' and 'Cancel' buttons at the bottom right.

6.2.7 – Status variables configuration

Status Variables are internal math channels that can have only two different values: 1 (TRUE) or 0 (FALSE). They may be useful for simplifying complex configurations, where it is required to evaluate if to activate alarms, LEDs, Icons etc..

Let us explain with an example: we would like to turn ON a LED and an Icon when Water temperature reaches 100°C and the RPM are higher than 2000. Instead of defining the same logic for managing the icon and for managing the LED, we could define a Status Variable, Water Temp Alarm, and link Icon and LEDs to this variable. In this case, we could define:

- Water Temp Alarm is High when:
 - Water Temp is higher than 100°C and
 - RPM is greater than 2000.

And use Water Temp Alarm for managing Icons and LEDs.

As you may see, the Status Variables are more useful when the logic to be evaluated is complex and involves different channels. In order to define a Status Variable enter the proper TAB.

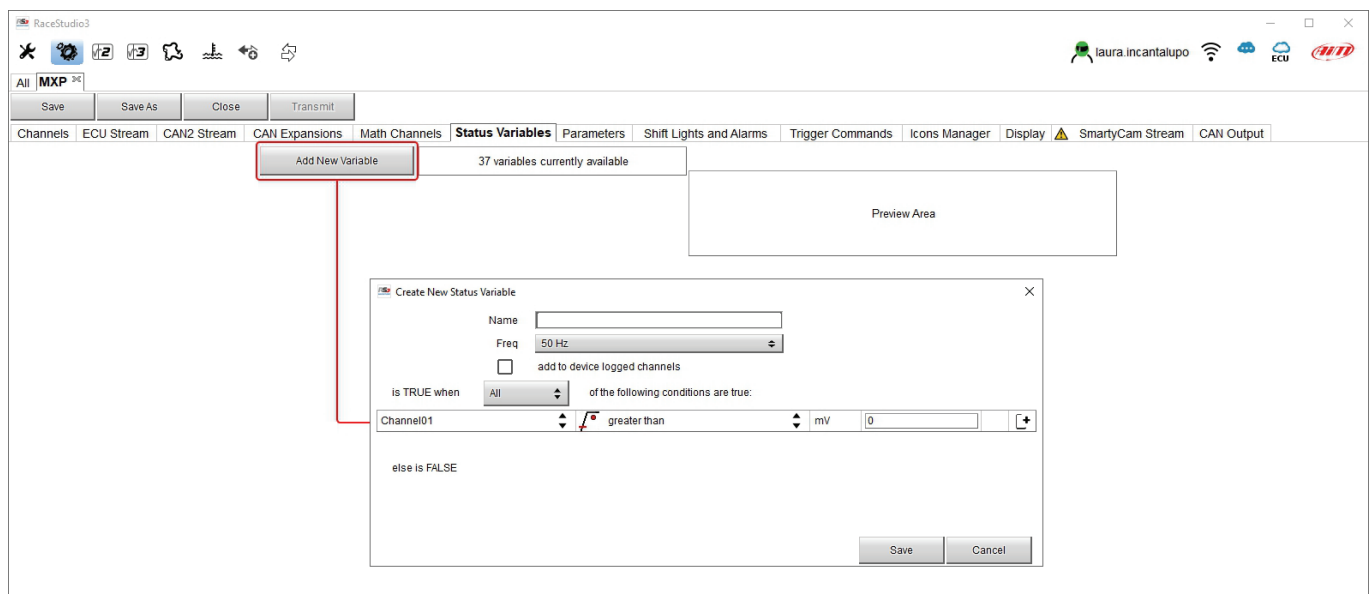

The Status variables can be used as any other channel, so they may be seen online, transmitted to the CAN stream, recorded, used for triggering a command or for turning ON a LED or an Icon.

Mousing over the Status Variable a summary panel appears on the right as shown here below.

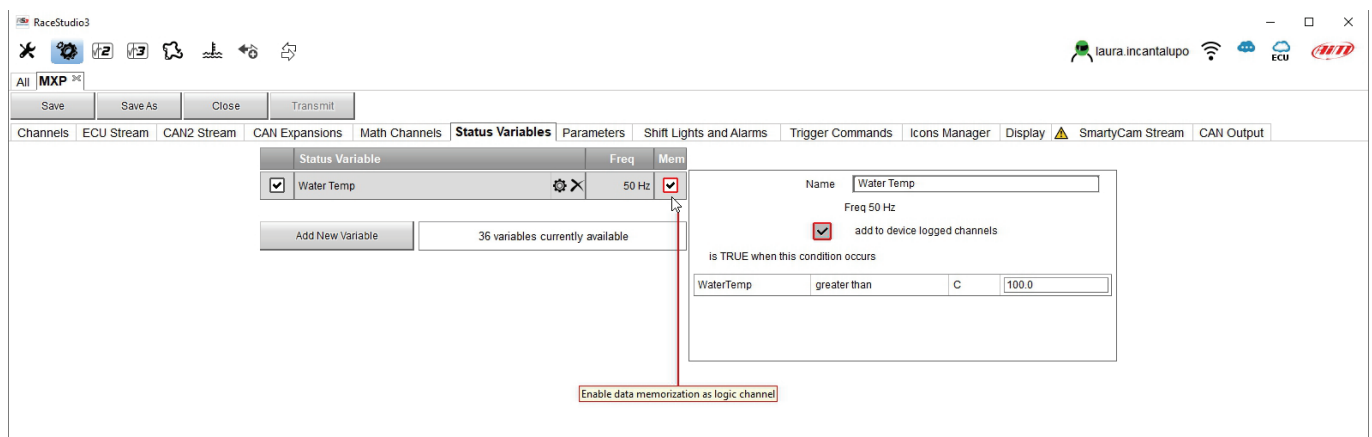

6.2.8 – Parameters configurationE

To set GPS and/or optional optical beacon (Lap detection) as well as decide the logger start data recording condition (Start Data Recording).

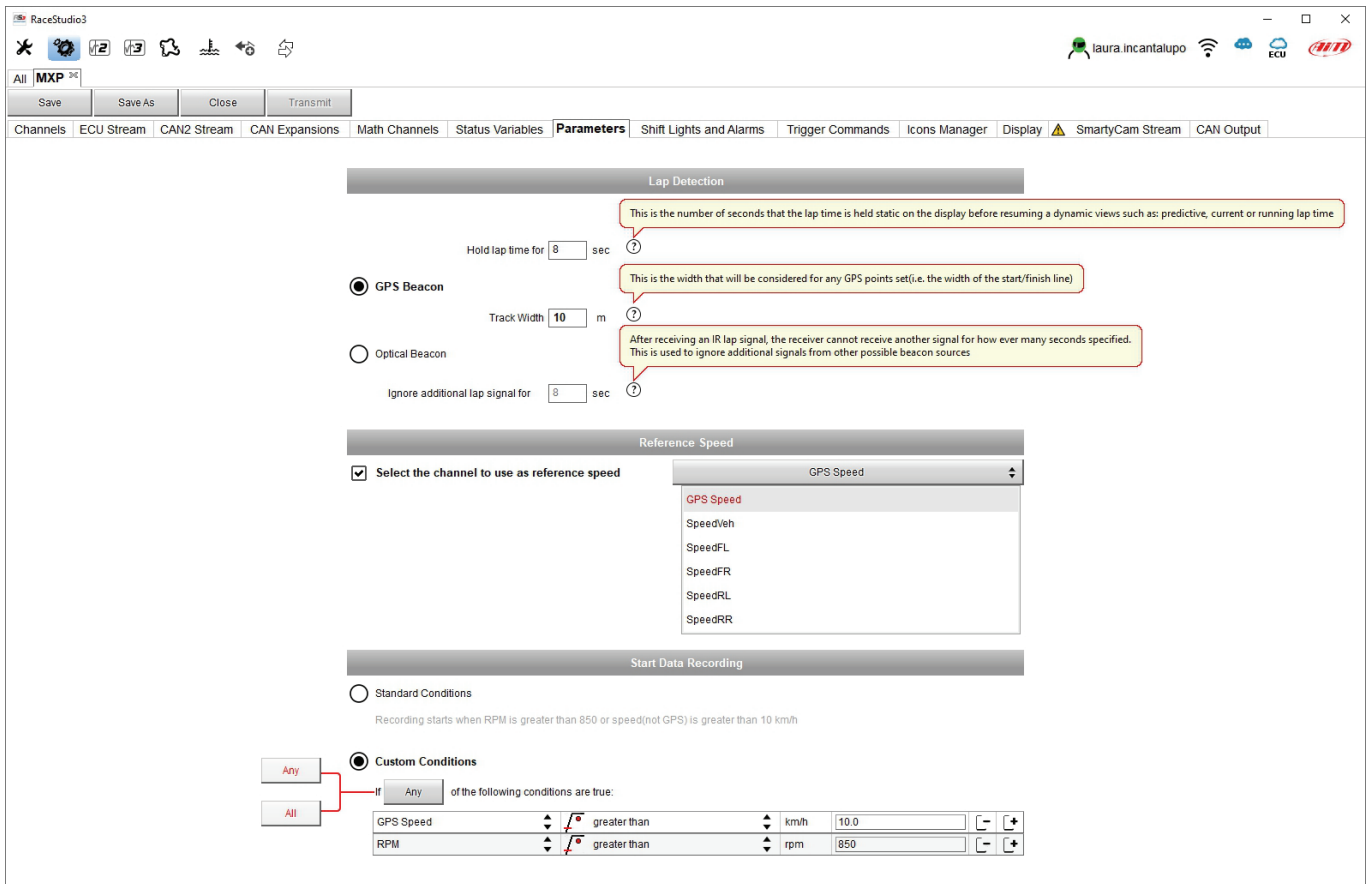

Lap Detection: mousing over the question marks a pop up message will explain the working mode of:

- GPS Beacon:
 - hold lap time for: the time period for which lap time is shown on MX Series display
 - the track width: width that will be considered for any GPS point set
- Optical beacon:
 - ignore additional lap signal for: after recording a lap signal, the receiver does not detect another one for the time period fixed in this box. This is very useful if more lap transmitters are placed nearby.

Reference Speed (Select the channel to use as reference speed): allows to select the speed to be used as reference one among these available.

Start Data Recording

- Standard conditions: the logger starts recording with RPM value greater than 850 or speed (not GPS) is higher than 10 km/h
- Custom conditions: to set one or more custom condition(s) to make the logger start recording. Setting more conditions, it is possible to decide whether only one of them or all need to be satisfied.

6.2.9 – Shift Lights and Alarms configuration

To set shift lights (on top) and set the alarm LEDs (bottom) of MX Series.



On top MX Series shift lights working mode can be set. Available options are:

- shift lights, for helping in changing gear and
- predictive time: for easily understanding if the actual lap is faster or slower than the reference lap.

Use as gear Shift Lights To use the led bar as shift lights click the icon (⚙️) for setting the parameters. Configure:

- at which RPM value the single LED turns ON
- the sequence mode of the LEDs enabling the desired option:
 - a LED stays on if its threshold is exceeded
 - a LED stays on until another LED with higher threshold turns on or
- link the shift lights to the engaged gear enabling the related checkbox;

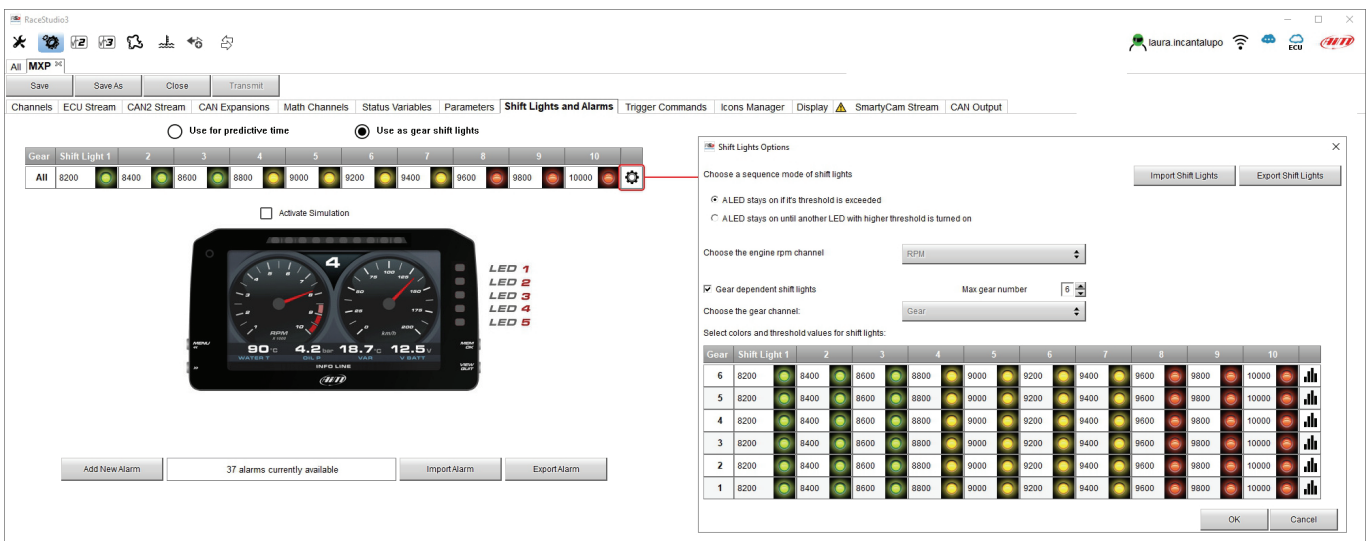

Use for predictive time. Click the icon for setting the parameters.

In this case the LEDs colour are by default fixed in:

- Green if the lap time is improving
- Red if the lap time is worse than the reference lap

The threshold at which one LED is turned ON can be customized. Assuming “0.10 sec” is fixed and the lap time is improving of 0.30 sec toward the reference lap, MX Series will switch on 3 LEDs green; if, on the contrary, the lap time is worsening the LEDs will switch on red.

The screenshot shows the RaceStudio3 interface with the 'Shift Lights and Alarms' tab selected. A table at the top lists LED settings:

Channel for LED-bars	Incremental time per LED	Better	Worse
+- Ref Time	0.10 sec		

Below the table is a digital dashboard with five LEDs labeled LED 1 to LED 5. A 'Predictive Time Bar Options' dialog box is open, showing the following settings:

- Choose a sequence mode of shift lights: A LED stays on if its threshold is exceeded
- Predictive Time Increment per LED: 0.1 (sec)
- Better Time LED Color: Green
- Worse Time LED Color: Red

Buttons at the bottom include 'Add New Alarm', '37 alarms currently available', 'Import Alarm', 'Export Alarm', 'OK', and 'Cancel'.

Create and set MX Series alarm

To create a new alarm press “Add New Alarm” and the related panel shows up. The software allows the user to set the condition(s) that switches the alarm LED on and the same condition(s) can– all or any – be applied to MX but can also create an event to any of the connected CAN expansion as shown here below and also allows the user to import/export settings too.

The screenshot displays the RaceStudio3 interface. The main window shows a dashboard with gauges and a gear shift light indicator. The 'Shift Lights and Alarms' tab is active, showing a table of gear shift lights and their corresponding RPM ranges. Below the table, there are buttons for 'Add New Alarm', 'Import Alarm', and 'Export Alarm'. The 'Add New Alarm' button is highlighted with a red box, and a red line connects it to the 'Create New Alarm' dialog box on the right.

The 'Create New Alarm' dialog box is open, showing the following configuration:

- Description:** [Empty field]
- If:** All of the following conditions are true:
- Channel01:** greater than mV [0]
- then trigger the following action(s):**
 - Alarm actions in MXP-**
 - Message:** [Insert message text]
 - Until:** condition no longer met
 - Alarm actions in RIO 02a or RIO 02b**
 - Output 1:** Open Circuit
 - Until:** condition no longer met
 - Alarm actions in Steering Wheel 3**
 - Popup Message timed:** [Insert message text] until alarm end
 - Until:** condition no longer met
- Buttons:** Save, Cancel

To set the new alarm:

- define the Alarm name (Description)
- one or more Alarm condition(s) can be set using the “+” button right of the panel: choose if the conditions are to be ALL valid or just one of them and decide which action(s) is/are to be triggered in the different devices
- decide the alarm ending condition (“Condition no longer met”)
- when all operations have been performed press “Save” in “Create New Alarm” Panel. CAMBIARE IMMAGINE

6.2.10 – Trigger commands configuration

“Trigger Command” executes some specific actions on MX Series.

Available commands are:

- Display page (next, previous, first and second camera input or go to a specific display page)
- display button command (any pushbutton)
- reset alarms whose ending condition is “a button is pushed”

To add a new command.

- Press “Add new Command”
- the related panel is prompted CAMBIARE IMMAGINE

The screenshot displays the RaceStudio3 software interface. The main window shows a list of Trigger Commands with columns for Event, Alarm, and priority. Two commands are listed: "Water Temp Alarm" and "Fuel". Below the list, there is a button labeled "Add New Command" which is highlighted with a red box. To the right of this button, it says "34 commands currently available". There are also buttons for "Import Command" and "Export Command".

A dialog box titled "Create New Output Command" is open, showing the configuration for a new command. It has a "Description" field, "Import" and "Export" buttons, and a dropdown menu set to "All". Below this, it says "of the following conditions are true:". A condition is set: "Speed1" greater than "0.0" km/h. Below the conditions, it says "then trigger the following action(s):". There are two sections for actions: "Command actions in MXP" and "Command actions in Steering Wheel 3". Both sections currently show "commands not yet associated to this event". At the bottom of the dialog are "Save" and "Cancel" buttons.

- Name the command and fix one or more condition(s) of the Trigger Commands deciding whether the conditions are to be ALL valid or just one of them CAMBIARE IMMAGINE
- decide the action to be performed by the device(s) connected
- Click "Save"

The screenshot displays the RaceStudio3 interface with the 'Trigger Commands' tab selected. A 'Create New Output Command' dialog box is open, showing the configuration for a new command named 'ParkAssistance'. The dialog includes a 'Description' field, a dropdown for 'If' (set to 'All'), and a list of conditions: 'All gears' with a value of 'R'. Below the conditions, there are two action fields: 'Command actions in MXP' with the value 'First Camera Input' and 'Command actions in Steering Wheel 3' with the value 'none'. The 'Save' button is highlighted with a red box.

Event	Alarm
<input checked="" type="checkbox"/>	Water Temp Alarm
<input checked="" type="checkbox"/>	Fuel

34 commands currently available

Create New Output Command

Description: ParkAssistance

If: All of the following conditions are true:

- All gears == equal to R

then trigger the following action(s):

- Command actions in MXP: First Camera Input
- Command actions in Steering Wheel 3: none

Save Cancel

In the Trigger Commands summary page, trigger command can be modified/deleted right clicking on the setting icon placed right of the trigger row.

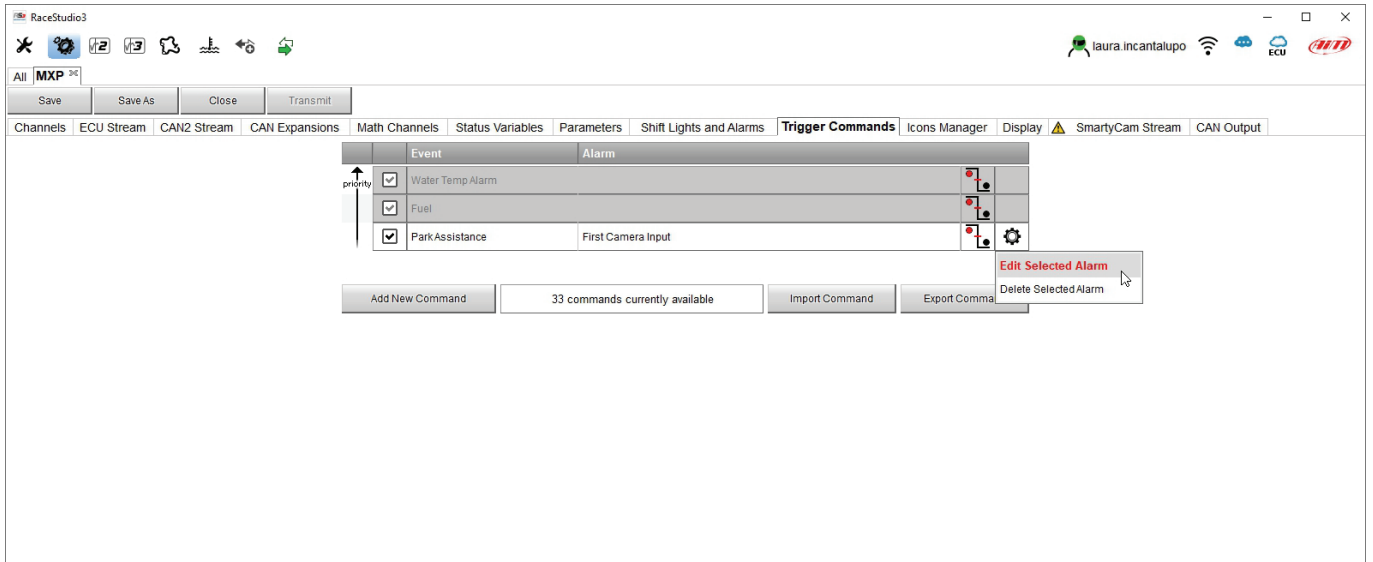

6.2.11 – Icons manager configuration

The “Icon” are a set of images that can be shown on the display when a fixed condition is true. A set of icons is provided by default; they can be modified and it is also possible to load custom icons.



For example:

- the first image is shown when the signal Turn Right is TRUE
- the second when the signal Turn Left is TRUE
- the third when the signal Hazard is TRUE
- the fourth when no signal is TRUE

To **configure an icon**:

- press “Add New Icon”
- “Manage Icon” panel shows up
- press “Select” to see the panel showing all images
- select “Predefined” layer to select the image to set among these available by default; select the desired one and press “OK”
- the software comes back to “Manage Icon” panel
- set the image conditions according to the channel they are related to

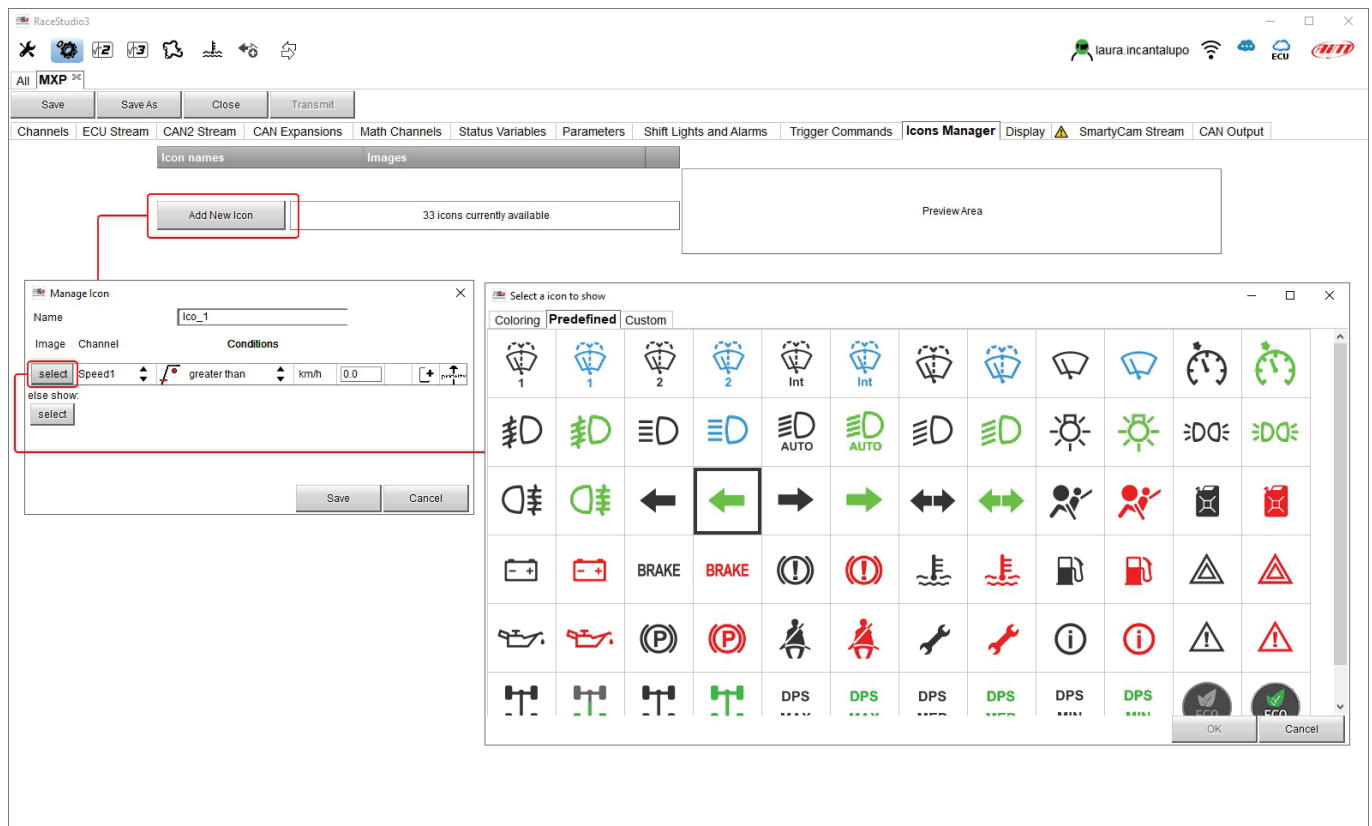

To modify an icon colour:

- select "Colouring" layer
- click on the icon to be coloured (ABS in the example below)
- two panel show up: left the panel showing the icon and right the panel where to choose the colour
- click on the desired colour (blue in the example)
- left panel shows the icon coloured
- press "OK"

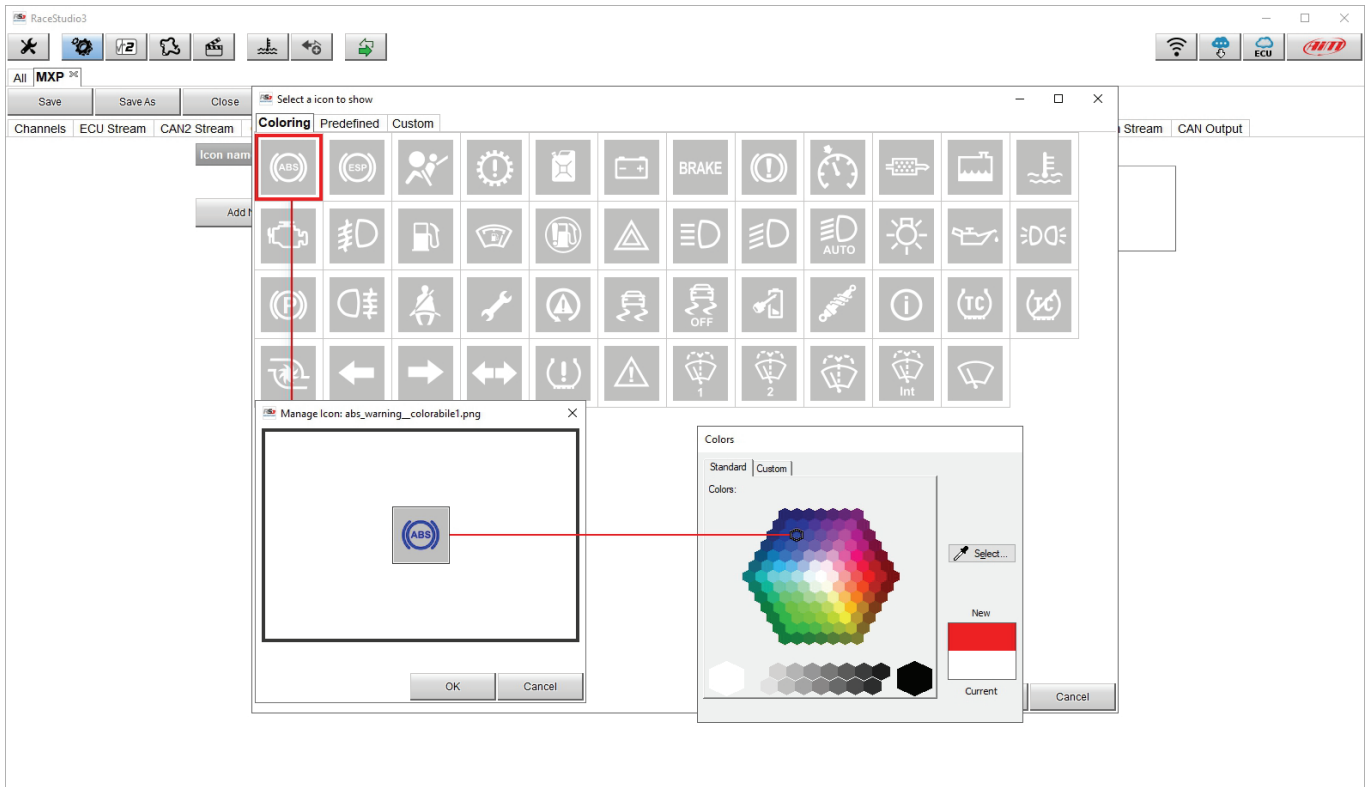

To load a custom icon:

- select "Custom2 layer"
- press "Add new"
- browse the folders and load the custom icon; images have to be a .bmp 64x64 pixels format
- press "OK"

At the end "Icon" page shows the icons set. Click them to modify.

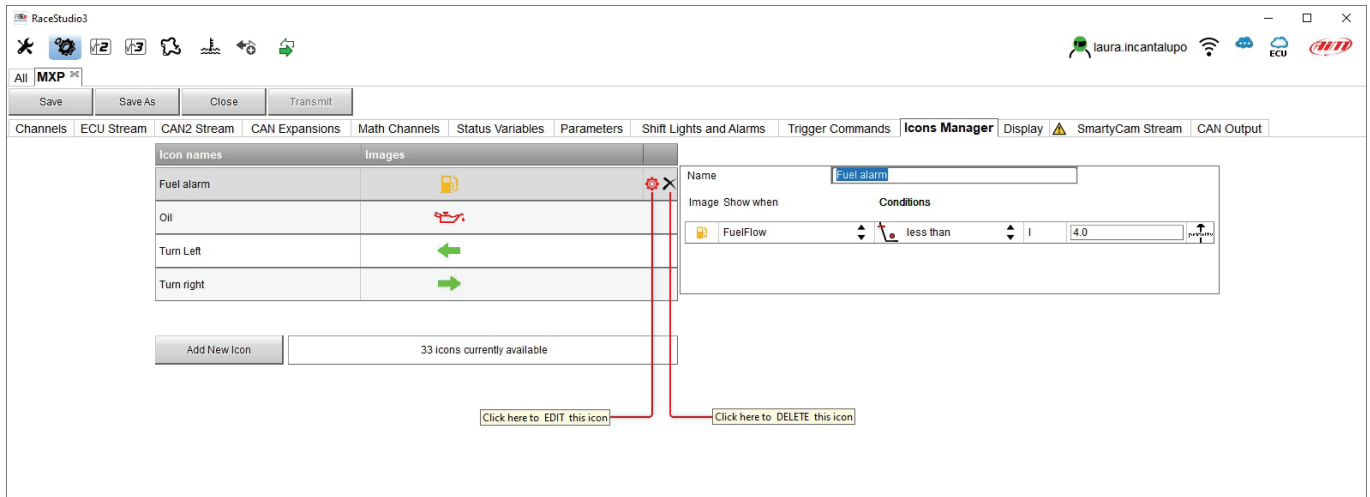

6.2.12 – Display configuration

MX Series can have up to eight pages to be set via software.

- enter “Display” tab
- a panel shows up: select a display page (in the example a page with icons bar has been chosen)
- select the page and press “OK”
- repeat the operation for the number of pages to set

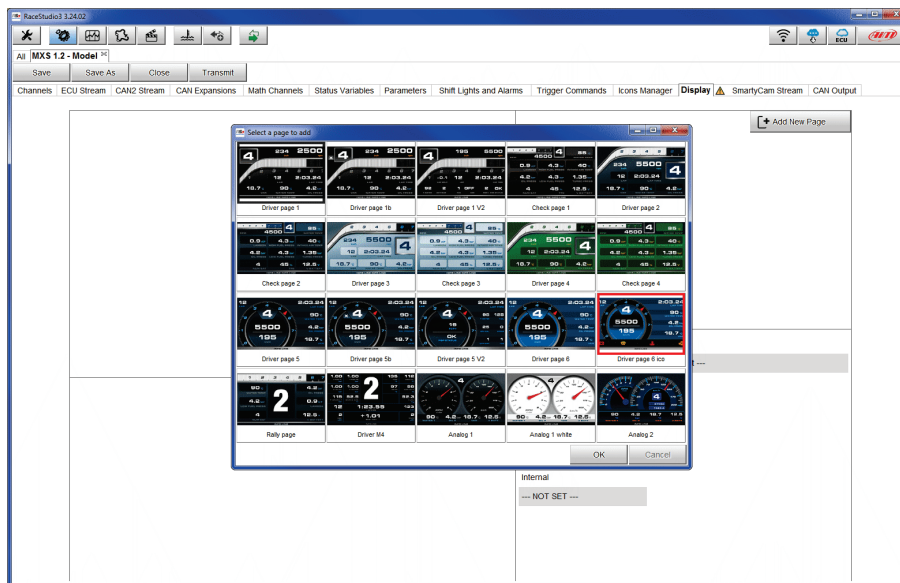

When the page has been selected two setting panels appear bottom of the page:

- on the left a panel that shows as many rows as the fields to be set
- on the right a panel that shows the channels group that can be set in that field and all the channels in it included; drag and drop the channel to set in the desired field or double click on it
- if more display pages have been added a label top central of the preview box indicates the one in use as highlighted here below.

The screenshot shows the RaceStudio3 interface. At the top, there's a menu bar with options like 'Channels', 'ECU Stream', 'CAN2 Stream', 'CAN Expansions', 'Math Channels', 'Status Variables', 'Parameters', 'Shift Lights and Alarms', 'Trigger Commands', 'Icons Manager', 'Display', 'SmartyCam Stream', and 'CAN Output'. Below the menu is a toolbar with 'Save', 'Save As', 'Close', and 'Transmit' buttons. The main display area is divided into two parts: a large dashboard on the left and a configuration panel on the right.

The dashboard displays various metrics: '99999' (LAP Num58), '99:99:99' (Lap Time), '99999 #' (TCSEngEvent), '99.99 %' (FuelInst1), and '999.9 C' (WaterTemp). A speedometer shows '9999 km/h'. There are also icons for fuel, oil, and turn directions.

The configuration panel on the right is titled 'INFO LINE' and contains a table of settings:

Field	Checked	Unit/Value
LAP	<input checked="" type="checkbox"/>	LAP Number
RPM	<input type="checkbox"/>	RPM
RPM	<input type="checkbox"/>	RPM 18000
Gear	<input type="checkbox"/>	Gear
GPS Speed	<input type="checkbox"/>	GPS Speed km/h
Lap Time	<input checked="" type="checkbox"/>	Lap Time
TCSEngEvent	<input checked="" type="checkbox"/>	TCSEngEvent #
FuelInst1	<input checked="" type="checkbox"/>	FuelInst1 %
WaterTemp	<input checked="" type="checkbox"/>	WaterTemp C
Icon: 'Fuel alarm'		
Icon: 'Oil'		
Icon: 'Turn Left'		
Icon: 'Turn right'		

Below the 'INFO LINE' table is a 'Channel Groups' and 'Channels' list. The 'Channels' list includes: LAP, Lap Time, Best Time, Predictive Time, Rolling Time, Rolling Sess Time, and Ref Time. The 'LAP' channel is selected. To the right of this list are settings for 'Digit Font' (MicrogrammaDBolExt, size 42), 'Label Font' (MicrogrammaDBolExt, size 20), and 'Position' (Alignment: left).

6.2.13 – SmartyCam stream setting

MX Series can be connected to both AiM SmartyCam2 and SmartyCam 3 through the CAN Bus to show the desired data on SmartyCam video. The logger transmits data to the Cameras in two slightly different ways according to the camera and to the fixed setting. Available options are

- SmartyCam 2 and SmartyCam 3 Default
- SmartyCam 3 Advanced CAMBIARE IMMAGINE

For MX to transmit each channel when connected to SmartyCam2 or SmartyCam 3 with default setting:

- click on it and a setting panel shows up
- it shows all channels and/or sensors that fits the selected function
- in case the desired channel or sensor is not in the list enable “Enable all channels for functions” checkbox and all channels/sensors will be shown

AiM default protocol transmits a rather limited range of information, enough for a wide range of installation.

ID	SmartyCam Function	Channel
CC01	Engine RPM	RPM
CC02	Speed	GPS Speed
CC03	Gear	Gear
CC04	Water Temp	WaterTemp
CC05	Head Temp	--- Not Set ---
CC06	Exhaust Temp	--- Not Set ---
CC07	Oil Temp	--- Not Set ---
CC08	Oil Press	Oil Pressure
CC09	Brake Press	--- Not Set ---
CC10	Throttle Pos	--- Not Set ---
CC11	Brake Pos	--- Not Set ---
CC12	Clutch Pos	--- Not Set ---
CC13	Steering Pos	SWAngle
CC14	Lambda	LCU 0Lambda
CC15	Lateral Accel	LateralAcc
CC16	Inline Accel	--- Not Set ---
CC17	Fuel Level	--- Not Set ---
CC18	Battery Voltage	Battery
CC19	Vertical Accel	--- Not Set ---

To transmit a different set of information you need a **SmartyCam3 with advanced setting**; please note: this function is for expert users only you may do as follows:

- configure MX logger in order to transmit a different SmartyCam stream
- select the desired SmartyCam stream in SmartyCam 3 configuration
- select “**SmartyCam 3** → **Advanced**” option in SmartyCam Stream tab
- press “Add new Payload”
- create your desired stream defining the required IDs fields and save it pressing “OK”
- name the protocol CAMBIARE IMMAGINE

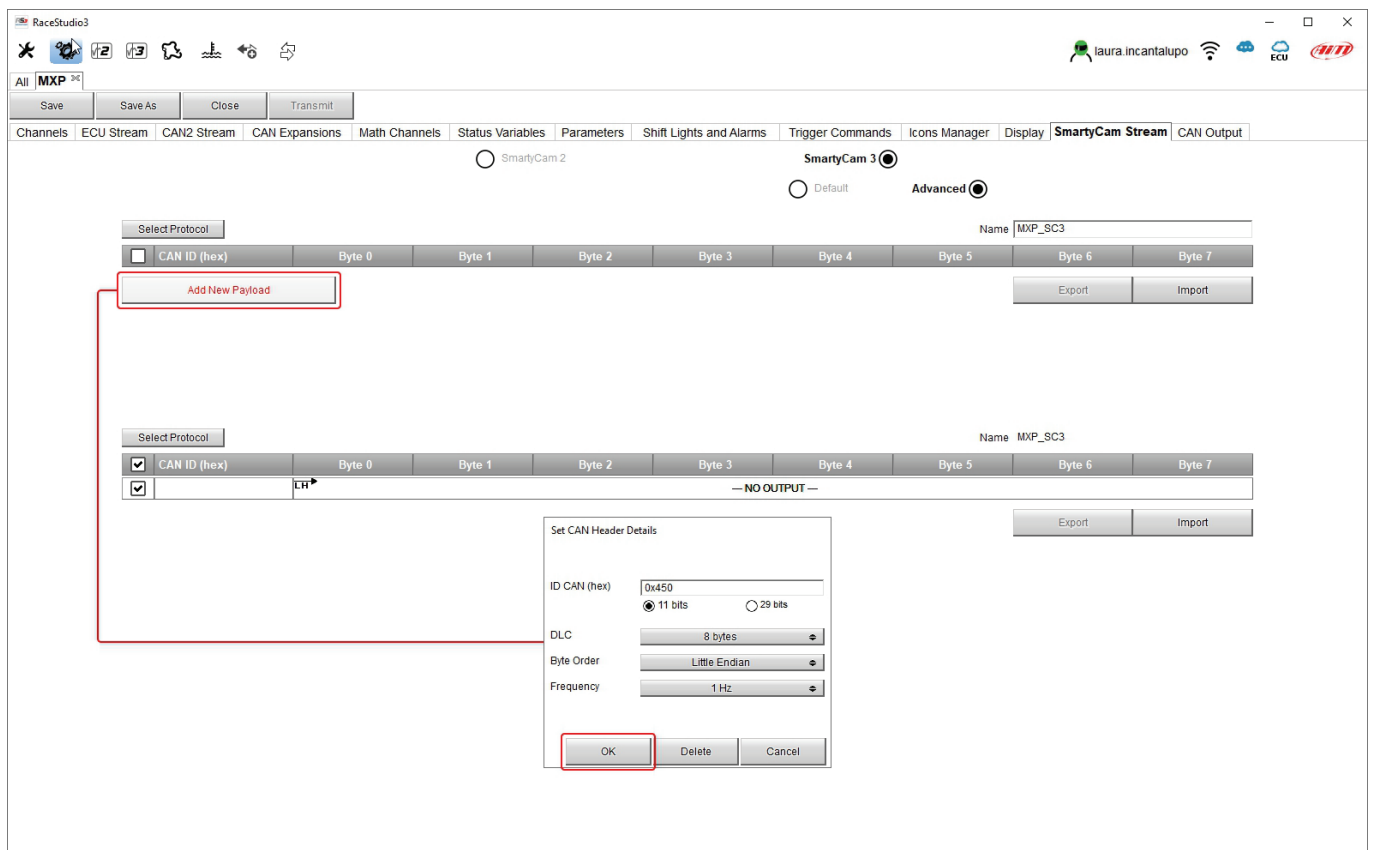

6.2.14 – CAN Output configuration

The logger can transmit a CAN data stream containing the channels required both on CAN1 and CAN2. It works exactly as SmartyCam 3 advanced stream

6.2.15 – Transmitting the configuration to MX loggers

When all channels set the configuration is finished:

- press “Save” on the page top keyboard
- press “Transmit” to transmit the configuration to MX Series



As said before:

- **MX1.3 loggers do not support thermocouple sensors except through a TC Hub** so if you set these sensors you need to add a TC Hub to AiM network
- **MX1.3 loggers miss the inertial platform**

For this reason if your configuration includes one or both of these features and no TC Hub is connected when you transmit the configuration to the logger the panel shown below is prompted.

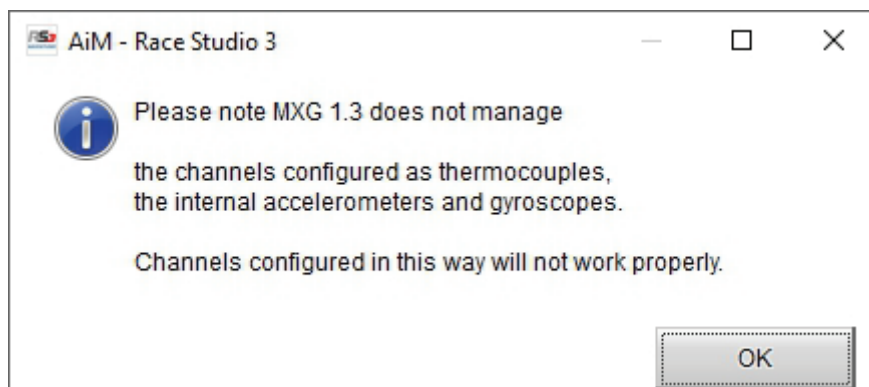

6.3 – Managing a track on MX Series with Race Studio 3

With Track Manager function of Race Studio 3 tracks can be created, deleted and modified, transmitted and received to/from MX Series. Press “Tracks” icon.



The main page is divided in three columns; on the **left**:

- on top, the filters that allow to collect many tracks following customized criteria; by default, all tracks are shown (light blue “All Tracks” filter in the image below).
- bottom left, the connected devices (in the image, “MXS 1.2 ID 4202523”)

The column **in the middle** shows:

- on top a fast search bar that allows to select the tracks which satisfy personal research criteria; pressing “?” a pop-up window explains research criteria (highlighted in red below), to say:
 - long name is the name in bold in each track box
 - short name is the track name shown on the display of MX Series and is the name shown top right of each track box
 - track city is the name of the city the track is located in
- all the tracks listed in Race Studio 3 database. It automatically updates at start up if a connection to the Internet is available.

The column on the **Right** shows:

- the data sheet of the track you are mousing over.

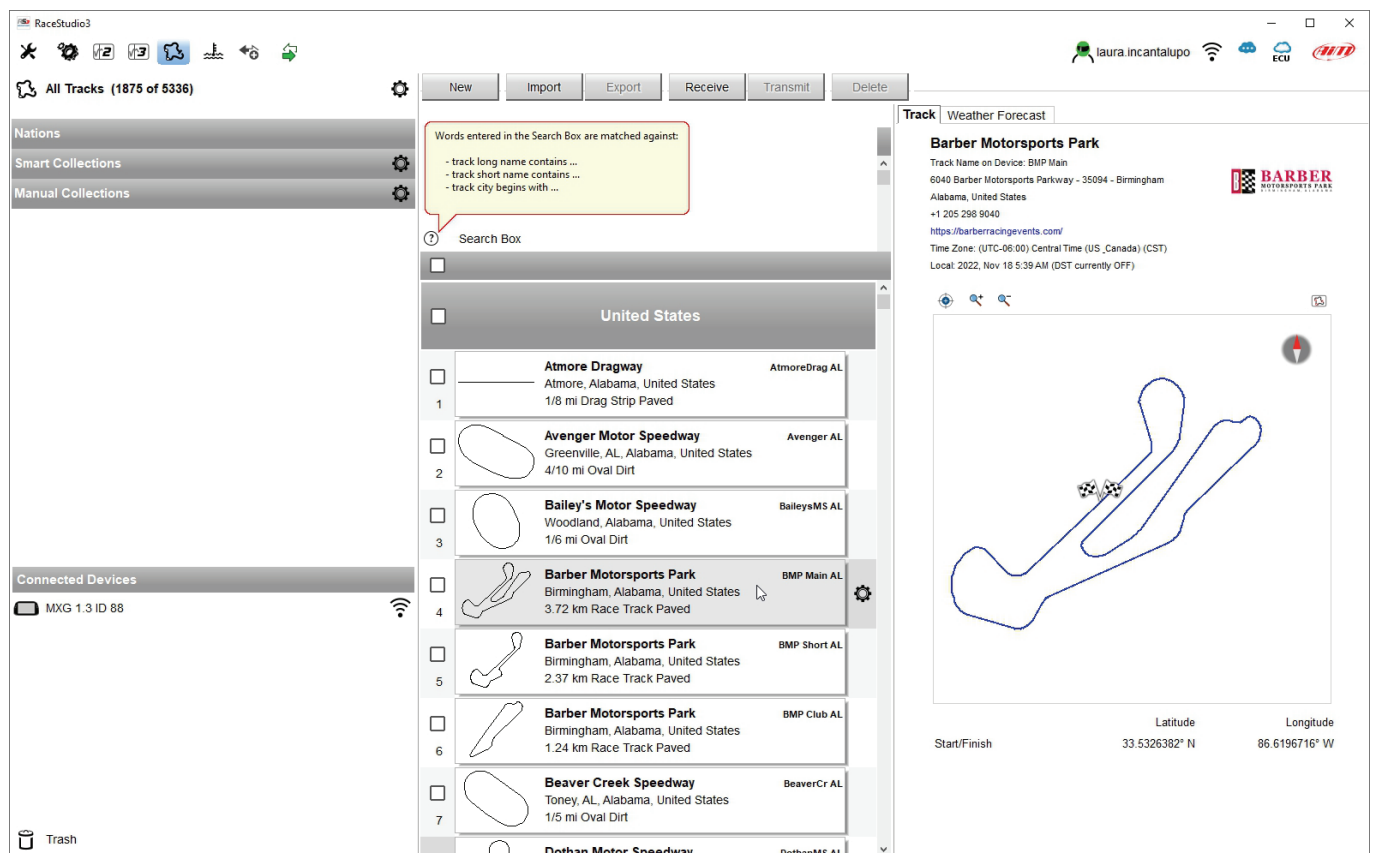



When MX Series is connected it is shown on the left bottom part of the page as said before. Clicking on it all the tracks it contains are shown in the right column of the page.

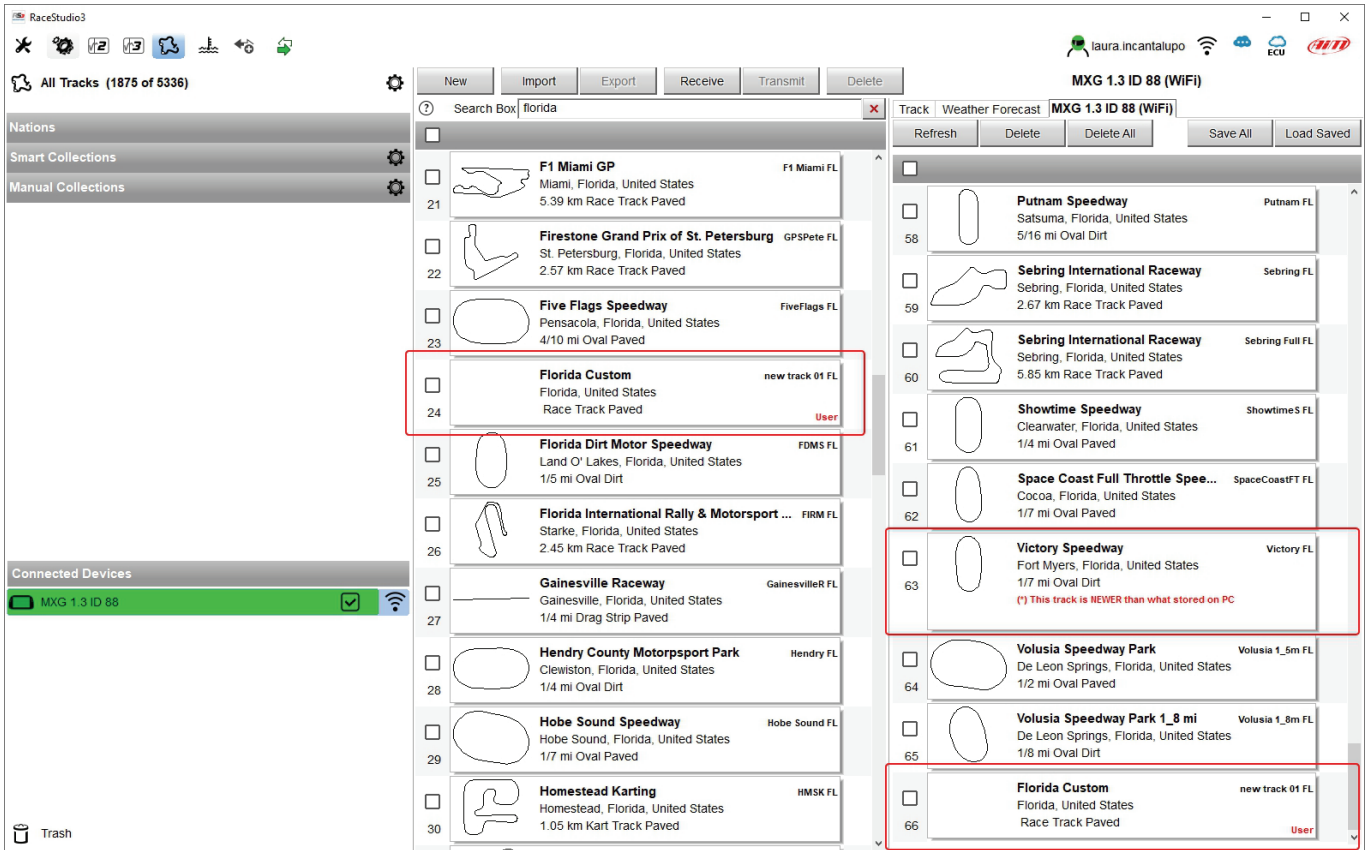

Tracks created by the user are labelled "User" and if the track stored in MX Series logger is different from the one stored on AiM database this is notified as shown here above.

The page keyboards are used to manage the tracks.

The keyboard above the central column allows to:



- **New:** create a new track ("Custom", see paragraph 4.6). To create a custom track:
 - Press "New" and fill in the panel that show sup (you can also fill only the start/finish coordinates) or
 - Edit an existing track
 - Press "Save"
- **Import:** import one or more tracks stored in the device or in another external device
- **Export:** export one or more tracks to a specific PC folder or to another peripheral device
- **Receive:** receive from the connected device tracks user created (if no device is connected the button is disabled)
- **Transmit:** transmit one or more tracks from the PC to the connected device (if no device is connected the button is disabled)
- **Delete:** delete one or more tracks from Race Studio 3 database

The keyboard above the right column allows to:



- **Refresh:** refresh the track list stored in the connected device
- **Delete:** delete one or more tracks from the device memory
- **Delete All:** delete all tracks stored in the device memory
- **Save all:** save all the tracks stored in the connected device; it creates a zip file that can be loaded to another AiM device
- **Load Saved:** load the tracks previously saved in the device memory

Since the software is constantly updated, may be other information or features will be available soon. Please check our website www.aim-sportline.com, documentation area, software section "Track Manager" manual.

6.4 – ECU Driver builder



If the vehicle ECU is not included in Race Studio 3 software a specific CAN protocol can be created using CAN Driver builder. **This Race Studio function is for expert users only** as for the panel that shows up pressing the related button.

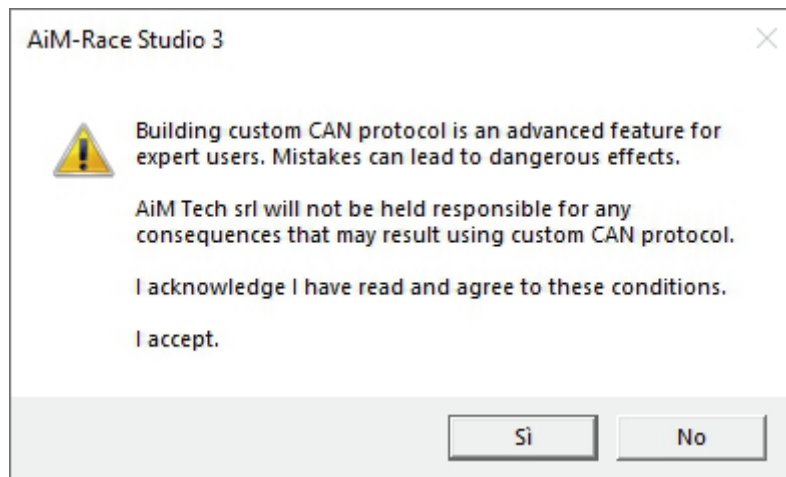

It is possible to add a new ECU Manufacturer and/or a new ECU model. To do so:

- press “New” on the top central keyboard
- “New Custom CAN Protocol” panel shows up
- press “Add Manufacturer” to add a new Manufacturer and “Custom Protocol Manufacturer Manager” panel shows up
- fill in the Manufacturer name (“Custom” in the example below)
- press “OK”
- to add a new ECU Model for an existing Manufacturer just select the manufacturer and fill in “Edit new model name” box.

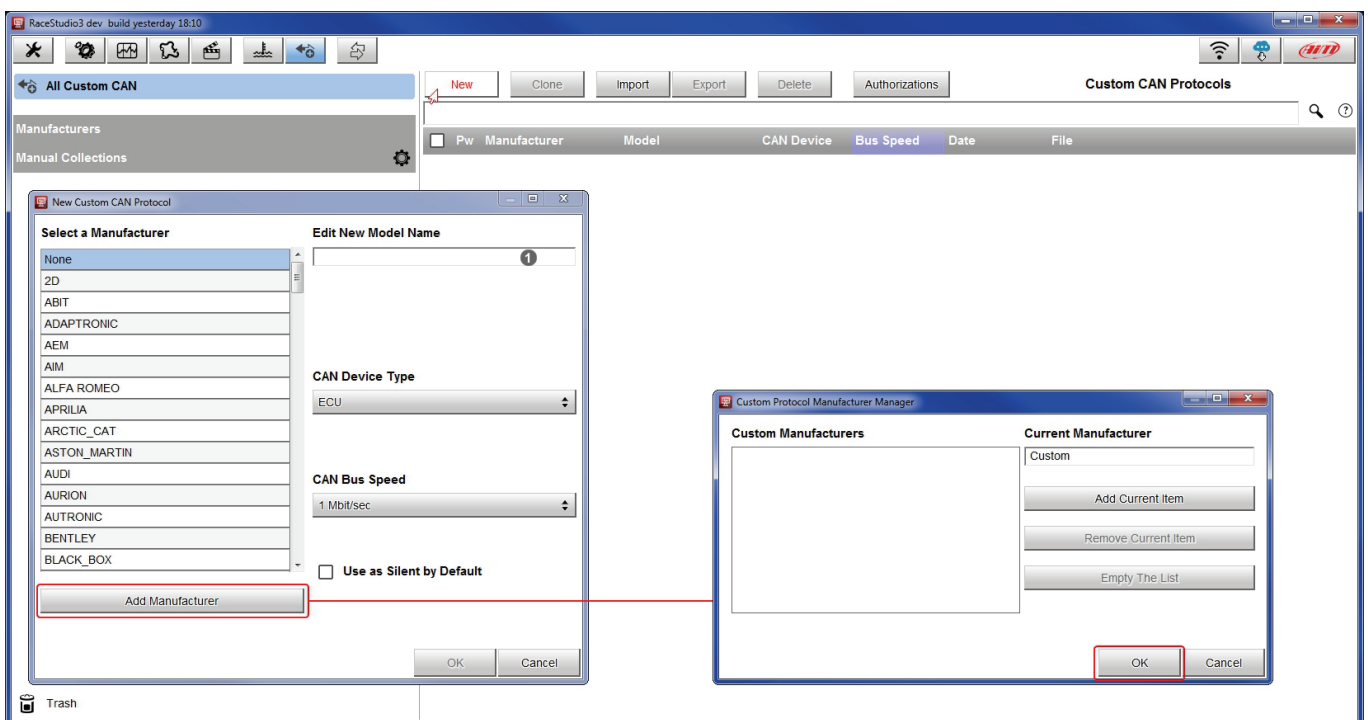

The software comes back to “New Custom CAN Protocol”:

- select the ECU Manufacturer previously created
- fill in the Model name in the panel top right box
- select the CAN Device type; available options are:
 - ECU
 - other CAN Devices
- select the CAN Bus speed; available options are:
 - 125 Kbit/sec
 - 250 Kbits/sec
 - 500 Kbit/sec
 - 1 Mbit/sec
- if the network features multiple devices we suggest to enable “Use a Silent by Default” checkbox
- press “OK” and a new CAN Driver has been added

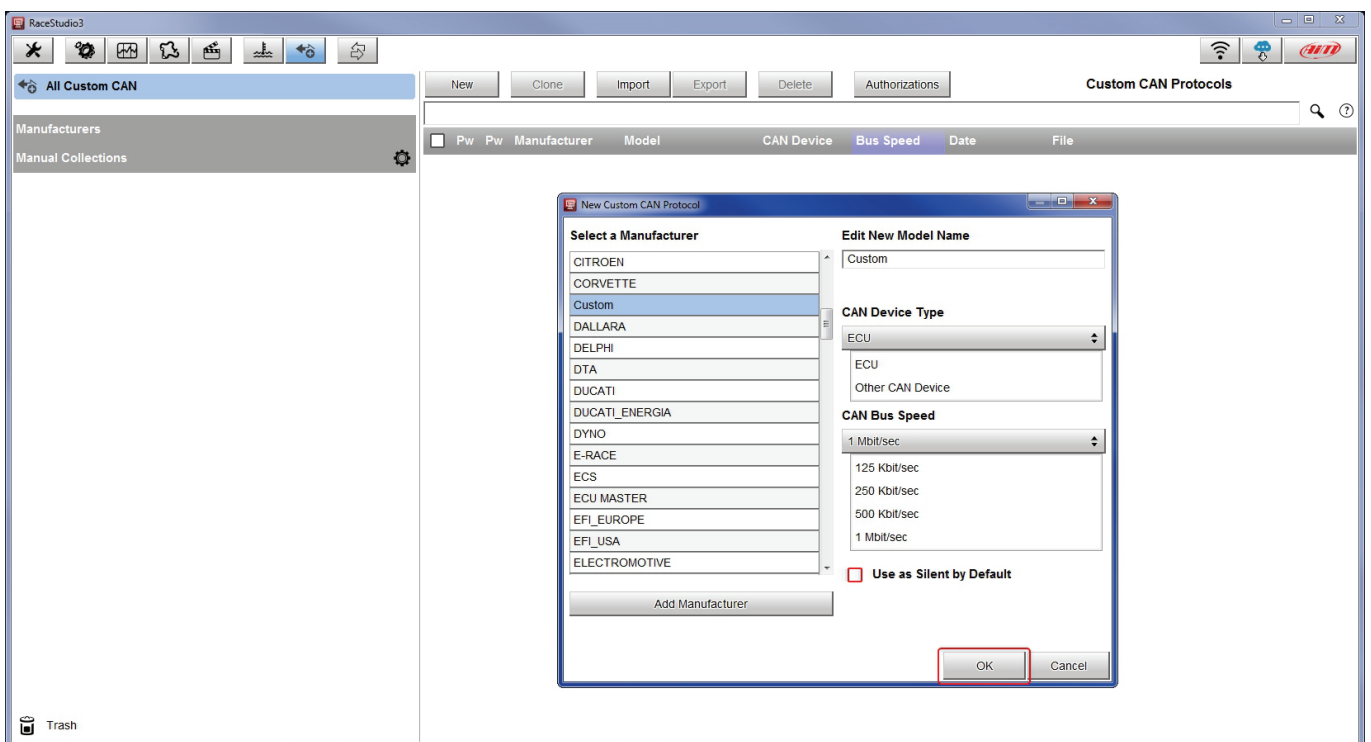

For further information about how to set the new CAN Driver refer to the CAN Driver builder user manual downloadable from www.aim-sportline.com, documentation area software/firmware section.

6.5 – The device window

The device window is shown clicking the device bottom left of the software page.

The screenshot shows the RaceStudio3 (64 bit) 3.32.12 application window. The title bar includes standard Windows window controls and system tray icons for Wi-Fi, ECU, and RIM. The main interface is divided into several sections:

- Top Menu:** A horizontal menu bar with options: Live Measures, Download, WiFi and Properties, Settings, Tracks, Counters, Logo, Firmware.
- Buttons:** A row of six numbered buttons (1-6) below the menu. Button 1 is 'Live Measures', 2 is 'Sort', 3 is 'Auto-calibrate', 4 is 'Mv', 5 is 'Recording', and 6 is 'LEDs'. A red box highlights these buttons.
- Left Panel:** Contains 'All Configurations', 'Devices', 'Manual Collections', and 'Connected Devices'. The 'Connected Devices' section shows 'MXP ID 75' with a Wi-Fi icon.
- Main Table:** A table displaying sensor data. It is divided into 'Master' and 'ECU channels' sections. The 'Master' section includes sensors like InlineAcc, LateralAcc, VerticalAcc, RollRate, PitchRate, YawRate, RPM, and Speed1-4. The 'ECU channels' section includes various flags and temperatures like POS PEDAL, G CH X, G CH Y, A STE, W CH, FLAG STW OUT1/2, FLAG FBX RELAY2, FLAG ABS, FLAG TCS OFF, N PTP REMAIN, POS ENG MAP, S PTP REMAIN, S FUEL, V WHL REF/RL/RR, T AIR, T ENG AIR, T GBX OIL, and T ENG OIL.
- Context Menu:** A menu is open over the 'Sort by Channel Type' option, showing 'Sort by Configuration', 'Sort Alphabetically', and 'Sort by Channel Type' (highlighted in red).

Top of the window (red hedged in the image below) are 8 layers used to:

- **Live Measures:** check device channels and force online values; the buttons of the top keyboard are to:
 - start live measures (1)
 - sort the channel visualization as preferred: as managed by the firmware (sort by configuration), alphabetically, by channel type: they will be shown by device then by channel type and at the end by measure type (2)
 - auto-calibrate sensors that need it (3)
 - show the measure in Mv (4)
 - start recording (5)
 - make the device LEDs blink (6); this is the easiest way to test PC-logger connection
- **Download:** to download data stored in MX logger
- **Wi-Fi and Properties:** to name the device, manage MX Wi-Fi (see chapter 5) fill in racer's and vehicle name or number, championship and venue type (generic or qualifying testing, warm up, race, test type)
- **Settings** to:
 - set date
 - enable/disable daylight time
 - set time format and time zone
- **Tracks:** to manage the tracks stored in the device memory
- **Counters:** to set/reset the device odometers
- **Logo:** transmit/receive the logo that shows up when switching the device on; supported image formats are JPEG or BMP; always use the most recent Windows™ versions (Windows8 or Windows10) whose graphic libraries are more updated
- **Firmware:** to check or update MX Series firmware version.

6.5.1 – Online value forcing

Device page Live measures layer features a new and very useful option: online measure value forcing. This feature allows the user to simulate one or more channels value to test icons, alarms, power output and harnesses behaviour.

With reference to the configuration we created it is possible to verify if Water Alarm status variable works.

The set conditions (paragraph 6.2.9) are: water Temperature greater than 100 +RPM greater than 2000. To force these values:

- mouse over the value to force and click the setting icon
- a popup menu appears: select “Force Value” option and fill in the panel that appears
- click “OK” and the LED blinks continuously as set in the device configuration.

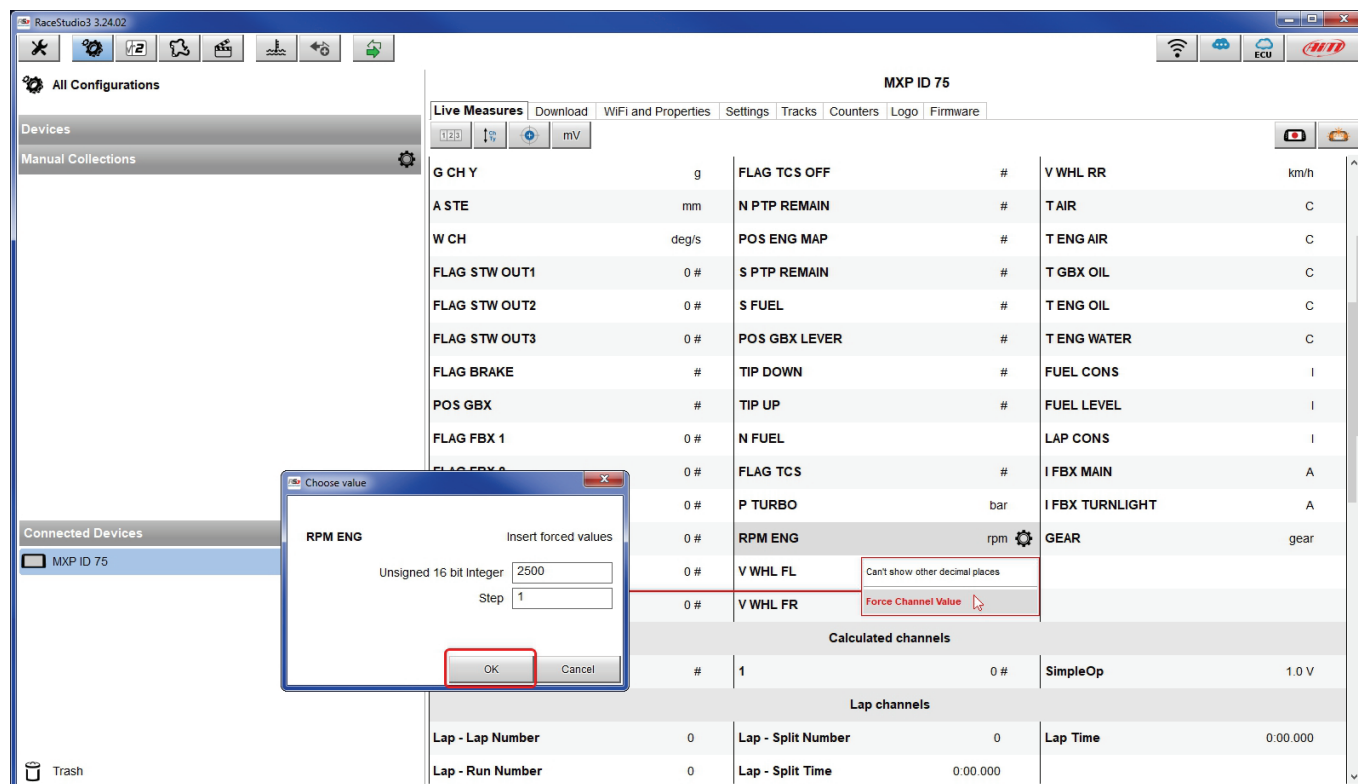

Channel Name	Unit	Channel Name	Unit	Channel Name	Unit
G CH Y	g	FLAG TCS OFF	#	V WHL RR	km/h
A STE	mm	N PTP REMAIN	#	T AIR	C
W CH	deg/s	POS ENG MAP	#	T ENG AIR	C
FLAG STW OUT1	0 #	S PTP REMAIN	#	T GBX OIL	C
FLAG STW OUT2	0 #	S FUEL	#	T ENG OIL	C
FLAG STW OUT3	0 #	POS GBX LEVER	#	T ENG WATER	C
FLAG BRAKE	#	TIP DOWN	#	FUEL CONS	I
POS GBX	#	TIP UP	#	FUEL LEVEL	I
FLAG FBX 1	0 #	N FUEL	#	LAP CONS	I
FLAG FBX 2	0 #	FLAG TCS	#	I FBX MAIN	A
FLAG FBX 3	0 #	P TURBO	bar	I FBX TURNLIGHT	A
FLAG FBX 4	0 #	RPM ENG	rpm	GEAR	gear
FLAG FBX 5	0 #	V WHL FL	#		
FLAG FBX 6	0 #	V WHL FR	#		

Calculated channels				
#	1	0 #	SimpleOp	1.0 V

Lap channels					
Lap - Lap Number	0	Lap - Split Number	0	Lap Time	0:00.000
Lap - Run Number	0	Lap - Split Time	0:00.000		



As shown in the image below, once the values have been forced they are shown right of the page red hedged. With the two "+" and "-" lateral buttons it is possible to change the forced values.

The screenshot displays the RaceStudio3 3.25.00 interface for MXP ID 75. The main window shows a table of live measures. The 'RPM ENG' value is highlighted in red and set to 2500 rpm. A control panel on the right side of the interface allows adjusting this value with '+' and '-' buttons.

Measure	Value
G CH Y	g
A STE	mm
W CH	deg/s
FLAG STW O...	0 #
FLAG STW O...	0 #
FLAG STW O...	0 #
FLAG BRAKE	#
POS GBX	#
FLAG FBX 1	0 #
FLAG FBX 2	0 #
FLAG FBX 3	0 #
FLAG FBX 4	0 #
FLAG FBX 5	0 #
FLAG FBX RE...	0 #
FLAG TCS OFF	#
N PTP REMAIN	#
POS ENG MAP	#
S PTP REMAIN	#
S FUEL	#
POS GBX LEV...	#
TIP DOWN	#
TIP UP	#
N FUEL	
FLAG TCS	#
P TURBO	bar
RPM ENG	2500 rpm
V WHL FL	km/h
V WHL FR	km/h
V WHL RR	km/h
T AIR	C
T ENG AIR	C
T GBX OIL	C
T ENG OIL	C
T ENG WATER	104.0 C
FUEL CONS	I
FUEL LEVEL	I
LAP CONS	I
I FBX MAIN	A
I FBX TURNLI...	A
GEAR	gear

Control Panel:

RPM ENG	+
2500 rpm	-
T ENG WATER	+
104.0 C	-



7 – On the track

MX Series can show up to eight pages. To scroll them press ">>" lateral button. Pages can change according to the device configuration.

8 – Data recall

At the end of the test sampled data can be recalled pressing "MEM/OK".

First is "Today" page.
Press "TESTS"

MAX RPM		MAX SPEED	
10048		282	
Lap	Best Laps	RPM	Km/h
4	1:57:56	10048 5592	280 73
11	1:57:94	10100 5450	277 70
8	1:58:02	10300 5700	278 69

Second is "Summary" page that shows all the last tests with date and place. Select the day you see and press "ENTER".

TEST SESSIONS
TODAY: COTA Austin
21/07/2018: Albany GA
21/07/2018: Albany GA
20/07/2018: Albany GA
20/07/2018: Albany GA

Third is "Day Summary" page that shows all tests in a box with time of the test, number of laps and best lap of the test. Select the test to see and press "ENTER".

TODAY: COTA Austin		
02.02 PM 17 Laps B 1.57.56	12.02 AM 10 Laps B 1.50.46	10.43 AM 11 Laps B 1.54.14
09.52 AM 7 Laps B 1.55.56	09.02 AM 9 Laps B 1.53.46	7.39 AM 10 Laps B 1.55.16

This page is a histogram test summary. Moving the cursor left and right all laps and their lap time are shown.

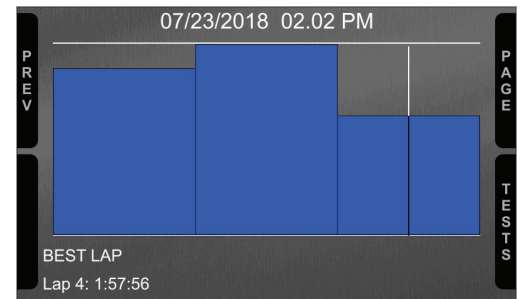

9 – Data download and analysis



Once the test session is over it is possible to download data sampled on a PC. Connect MX Series logger to a PC using the USB cable included in the kit or via Wi-Fi and click on it bottom left of the software page. Once reached the device page activate “Download”. layer It shows all the information concerning the file stored in the logger: number of laps, best lap, date/time, file dimensions. Select the file(s) to download and press “Download” button.

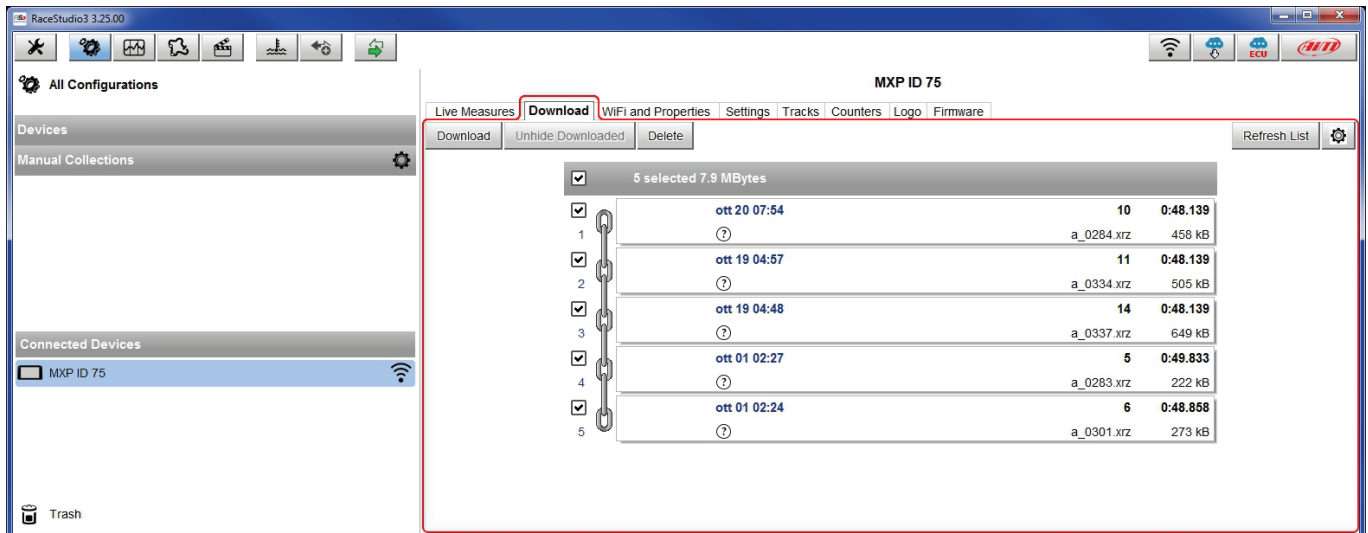

After download press Analysis Icon () and Race Studio Analysis software starts showing all the files available for analysis. Double clicking on the desired one it is possible to start analysing your performance.

10 – New firmware upgrade



Our technicians and engineers are constantly working to improve both the firmware (the application that manages the device) and the software (the application installed on the PC).

Each time a new firmware and/or software version is available the icon here above appears with an arrow indicating that something is available for download (otherwise the icon only shows the cloud).

Click it and freely download the new applications.

The screenshot shows the RaceStudio3 (64 bit) 3.32.12 interface. On the left, a 'Connected Devices' panel shows 'MXP ID 76'. The main area has tabs for 'Download', 'Install SW', 'Export', 'Import', and 'Update Device'. Below these is a table with columns for 'Name', 'On the web', 'Downloaded', and 'Info'. The 'On the web' column contains a red-bordered icon with a download arrow. Below this is a 'Software' section showing the installed version 'RaceStudio3 (64 bit) 3.32.12' and a list of other software versions. The 'Firmware' section lists various models with their current and available versions. Several rows are selected and highlighted in blue, with red boxes around the 'On the web' icons for those rows.

Name	On the web	Downloaded	Info
<input type="checkbox"/> RaceStudio3 (64 bit)	3.32.12		
Firmware			
<input type="checkbox"/> EVO4S	01.30.00	01.30.00	
<input type="checkbox"/> EVO5	01.30.00	01.30.00	
<input type="checkbox"/> MXG	01.30.00	01.30.00	
<input type="checkbox"/> MXL2	01.30.00	01.30.00	
<input type="checkbox"/> MXS	01.30.00	01.30.00	
<input type="checkbox"/> MXS Strada	01.30.00	01.30.00	
<input type="checkbox"/> MyChron5	01.30.00	01.30.00	
<input type="checkbox"/> SmartyCam HD	01.04.30	01.04.30	
<input type="checkbox"/> MX2E	02.32.79	02.32.79	
<input checked="" type="checkbox"/> MXG 1.2	02.32.81	02.32.72	
<input checked="" type="checkbox"/> MXG 1.2 Strada	02.32.81	02.32.72	
<input type="checkbox"/> MXK10	02.28.26	02.28.26	
<input type="checkbox"/> MXK10(11-15)	02.28.12	02.28.12	
<input checked="" type="checkbox"/> MXP	02.32.81	02.32.72	
<input checked="" type="checkbox"/> MXP Strada	02.32.81	02.32.72	
<input checked="" type="checkbox"/> MXS 1.2	02.32.81	02.32.72	
<input checked="" type="checkbox"/> MXS 1.2 Strada	02.32.81	02.32.72	
<input type="checkbox"/> MX UTV	02.34.10	02.34.10	
<input type="checkbox"/> MXm	02.32.78	02.32.78	
<input type="checkbox"/> MXm-i	02.32.78	02.32.78	

Once the new firmware has been downloaded connect the device to the PC using the USB cable included in the kit or via Wi-Fi to perform a firmware upgrade. In a few seconds the device is ready.

11 – Connection with the expansions

MX Series can be connected to various AiM expansions like AiM GPS08 Module, LCU-One CAN, Channel expansion, TC Hub, RIO_02, Shift Light Module, Formula Steering Wheel 3 or GS Dash (the configuration only supports one display additional to MX Logger one) SmartyCam HD and SmartyCam GP HD in order to improve its functionality.

Please note that LCU-one, Channel expansion TC Hub, Rio 02, Shift Light Module, Formula Steering Wheel 3/GS Dash and SmartyCam HD have to be configured with Race Studio 3 software as already explained in the related paragraphs (“CAN Expansions configuration”, “Channels configuration” and “SmartyCam stream setting”). Moreover, please refer to the related user manuals for further information concerning AiM expansions and AiM SmartCam HD.

11.1 – Rear cameras connection and management

MX Series loggers can manage rear cameras through the 5 pins Binder 712 female connector labelled “VIDEO IN” and placed rear central as shown here below. Please see the logger pinout reported in chapter 12 (Technical information and drawings) for further information about the Binder pinout. The connector allows the connection of up to two analog cameras.



Rear cameras needs to be connected to the logger, set in the logger configuration through Race Studio 3 software and executed through the logger keyboard. Here follows explanation of how to perform all these operations.

A wide number of analog cameras, both PAL and NTSC, are compatible with MX Series loggers and patch cables for connecting most of them are available. Please refer to our website www.aim-sportline.com for more information about them.

Please note: rear camera dimensions and MX Series camera input pinout are shown in chapter 12.

Once "Gear" channel has been set it is necessary to create a new "Trigger command". To do so:

- press "Add new command"
- fill in the panel that shows up, in the example
 - description: park assistance
 - channel "Gear equal to R"
 - trigger the command "First camera input"

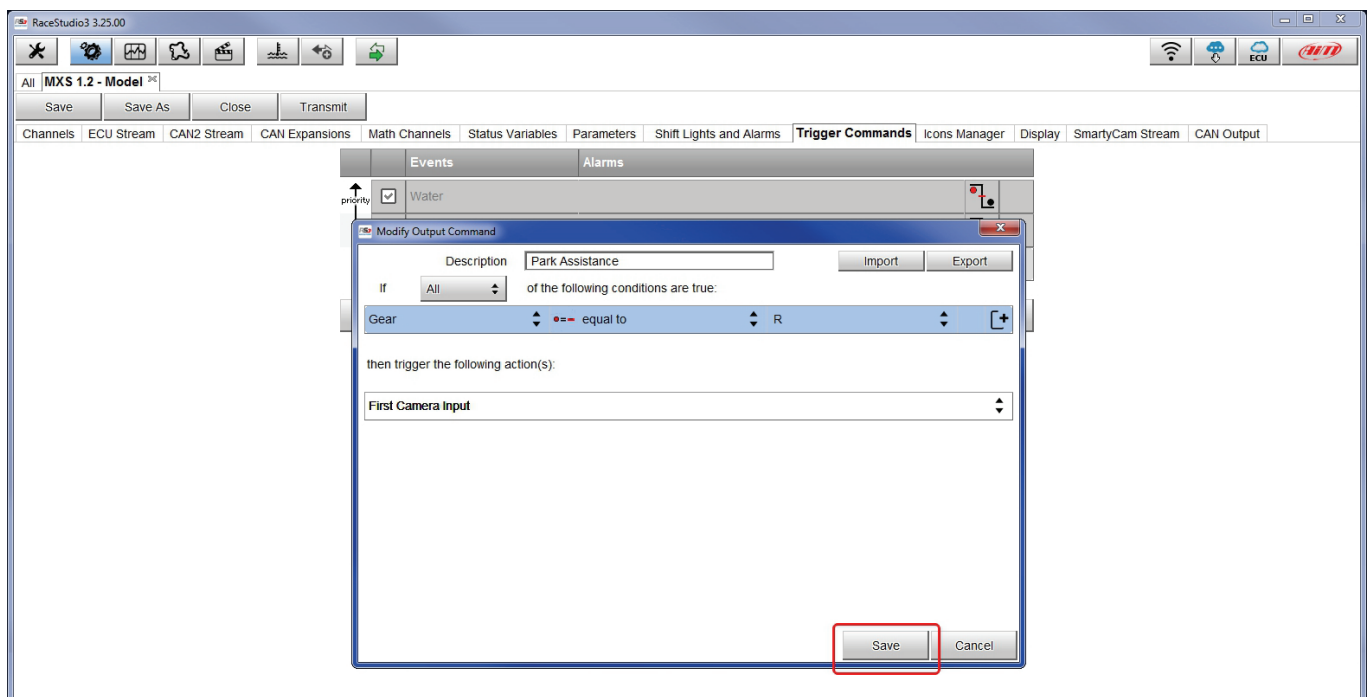

To perform the command on the logger press "MENU" button and scroll up to "VIDEO IN".



Set the camera as explained in paragraph 4.3. If no key is pressed in 5 seconds, the menu disappears and the logger shows the camera image in live streaming, that is very useful to check the camera position. Images below shows the image of the camera set on the left and the live stream on the right.

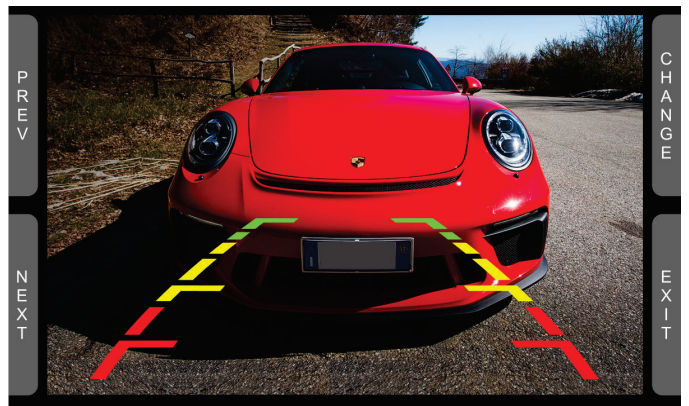
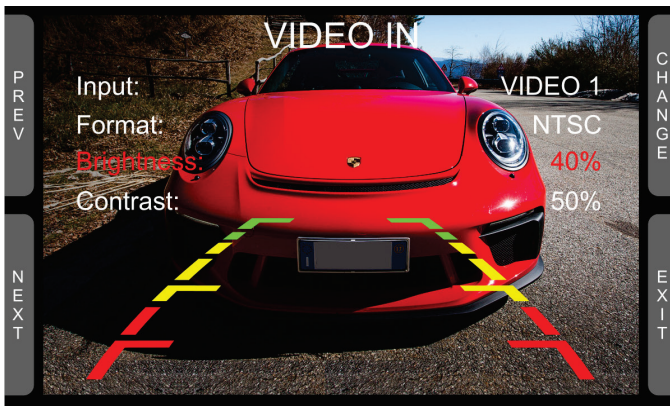



12 – Technical specifications and drawings

• TFT display dimensions	5" (MXS) 6" (MXP) 7" (MXG) 10" (MXT)
• Display resolution	800x480 pixels (MXS, MXG, MXP), 1280x480 (MXT)
• Contrast	600:1 (MXP, MXS) – 1000:1 (MXG 1.2) – 1.100:1 (MXT)
• Brightness	700cd/m ² (MXS, MXG, MXP) – 1,100 Lumen (MXT)
• Ambient light sensor	Yes
• Alarm display icons	Yes, freely configurable
• Alarm RGB LEDs	6 (MXS and MXT), 5 (MXP), 8 (MXG 1.2)
• Shift lights	10 configurable RGB LEDs
• Display pages	Up to 8 freely configurable
• Backlight	YES
• CAN connections	3
• Second CAN	Yes
• ECU Connection	CAN, RS232, K-Line to 1.000+ leading ECUs
• External Modules	GPS Module, Channel Expansion, LCU-Lambda Controller, TC Hub (necessary to connect thermocouple sensors on 1.3 and MXT loggers), RIO_02, Shift Light Module, Formula Steering Wheel 3 or GS Dash, SmartyCam HD
• Analog inputs	8 fully configurable, max 500 Hz each
• Digital inputs	4 Speed inputs, lap signal, coil RPM input
• Digital outputs	2 (1A max)
• Wi-Fi connection	Yes
• Inertial platform	Internal 3 axis gyro, magnetometer and ±5G accelerometer
• Internal Memory	4GB
• Power consumption	400 mA
• Pushbuttons	Metallic
• Connectors	2 motorsport connectors + 1 Binder connector
• Body	Anodized Aluminum
• Weight	530g (MXS 1.2) – 640g (MXP) – 950g (MXG) – 1.200g (MXT)
• Dimensions	169.4x97x23mm (MXS) 189.6x106.4x24.9mm (MXP) 237x127.6x26mm (MXG) 278x135x43.2mm (MXT)
• Waterproof	IP65

12.1 – MX Series Pinout and dimensions

MX Series pinout

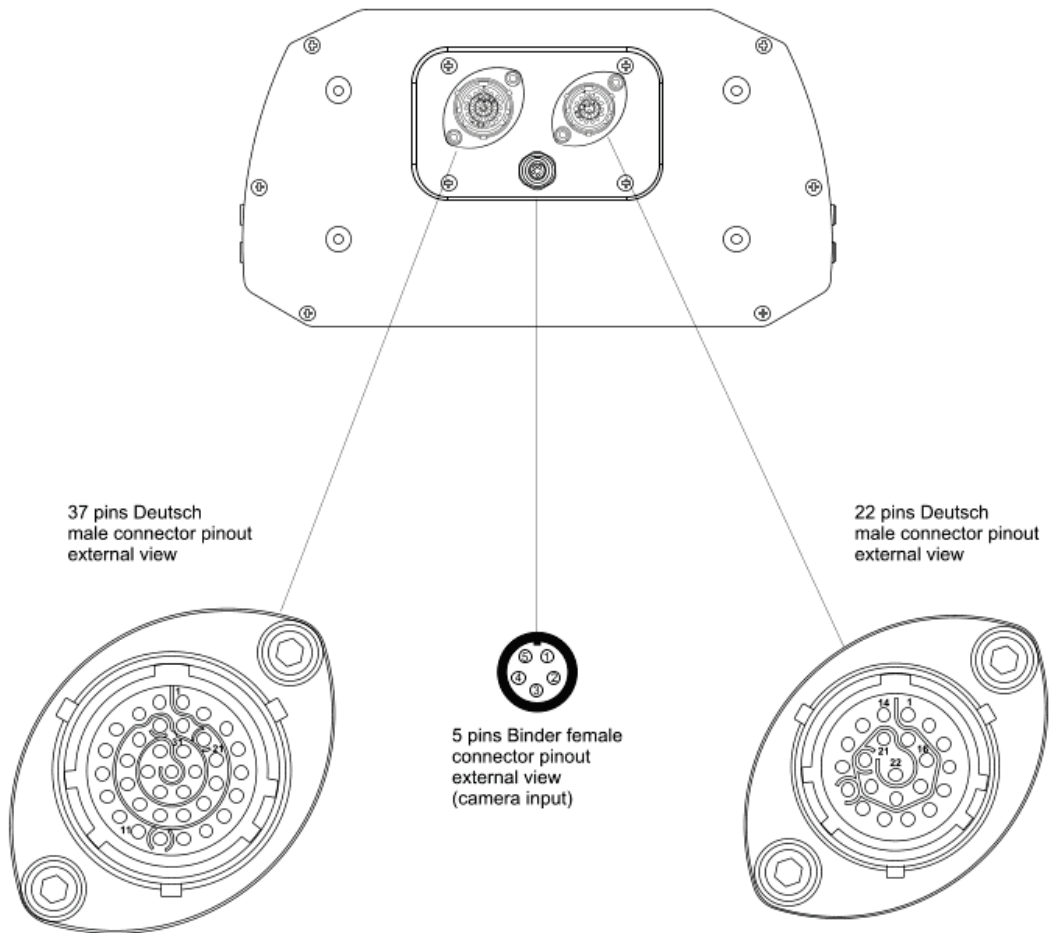

Pin	Deutsch 37 pin
1	9-15V Power input
2	Battery GND
3	CAN+ Exp
4	GND
5	+Vbattery CAN
6	CAN- Exp
7	+Vb Ext
8	CAN1+ ECU
9	CAN 1- ECU
10	GND
11	K Line ECU
12	USB D+
13	USB D-
14	GND
15	RPM
16	GND
17	+Vbattery
18	Optical Lap
19	Speed1

Pin	Deutsch 37 pin
20	GND
21	+Vbattery
22	Analog Input 1
23	Analog GND
24	+Vbattery
25	+Vreference
26	Analog Input 2
27	Analog GND
28	+Vbattery
29	+Vreference
30	Analog Input 3
31	Analog GND
32	+Vbattery
33	+Vreference
34	Analog Input 4
35	Analog GND
36	+Vbattery
37	+Vreference

Pin	Binder
1	Video input 1
2	GND
3	+Vb output Camera
4	GND
5	Video input 2

Pin	Deutsch 22 pin
1	Analog Input 5
2	Analog GND
3	+Vbattery
4	+Vreference
5	Analog Input 6
6	Analog Input 7
7	Analog GND
8	+Vbattery
9	+Vreference
10	Analog Input 8
11	Speed 2
12	GND
13	+Vbattery
14	Speed 3
15	Speed 4
16	GND
17	CAN2+ ECU
18	CAN2- ECU
19	Digital output 1
20	Digital output 2
21	ECU RS232 Rx
22	ECU RS232 Tx



MXT dimensions in mm [inches]

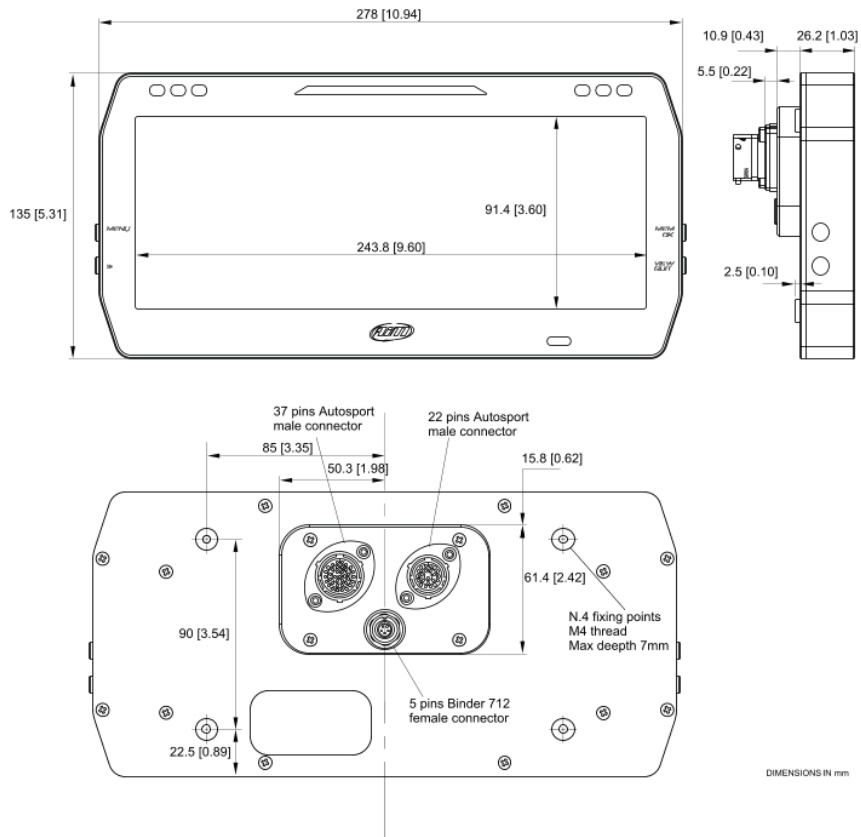



MXG dimensions in mm [inches]

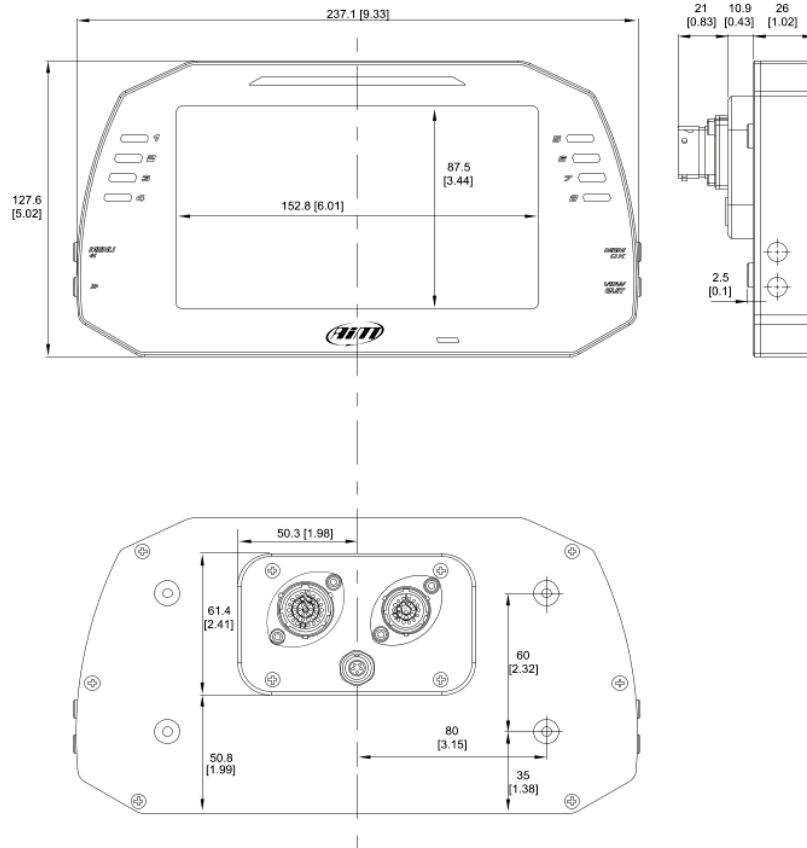



MXP dimensions in mm [inches]

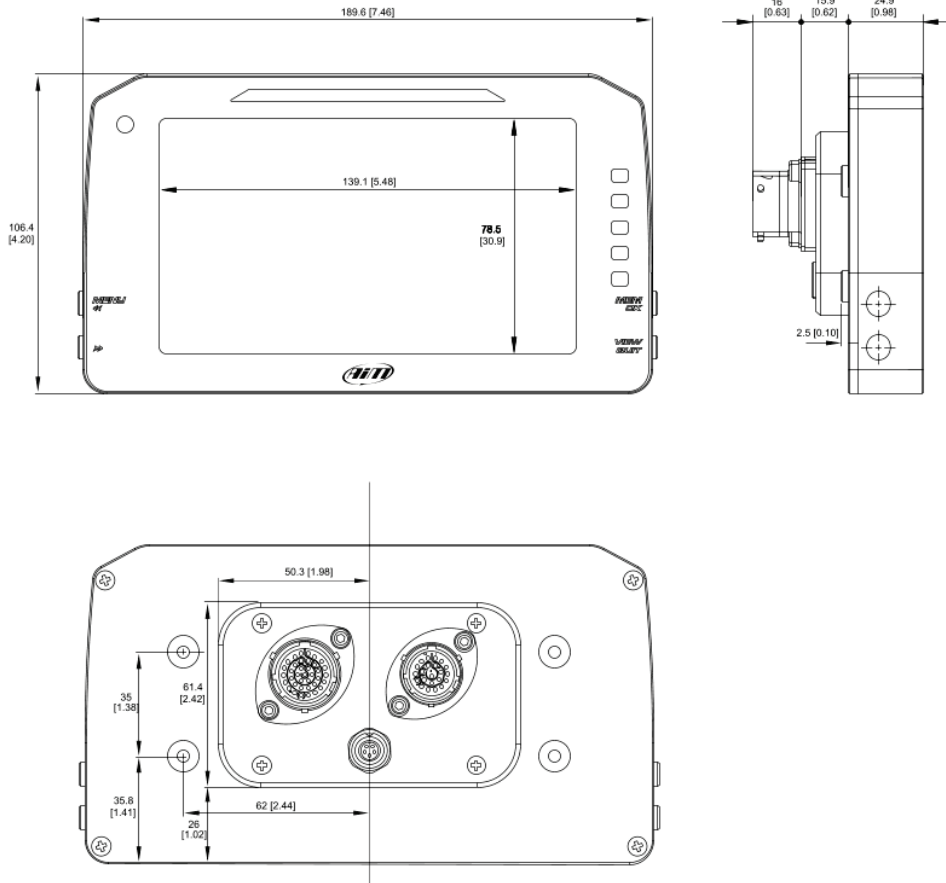



MXS dimensions in mm [inches]

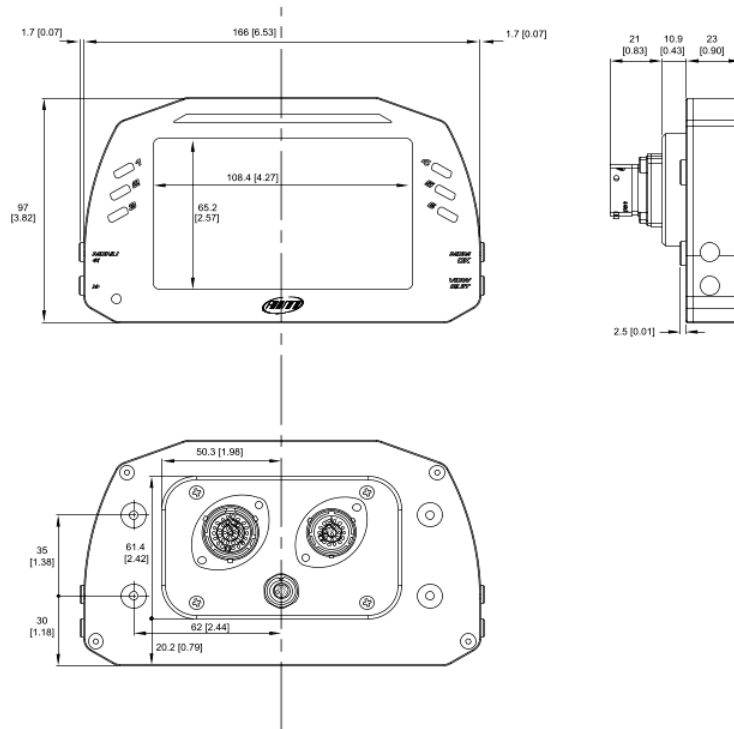

12.2 – MX series harnesses

37 pins Deutsch connector standard harness

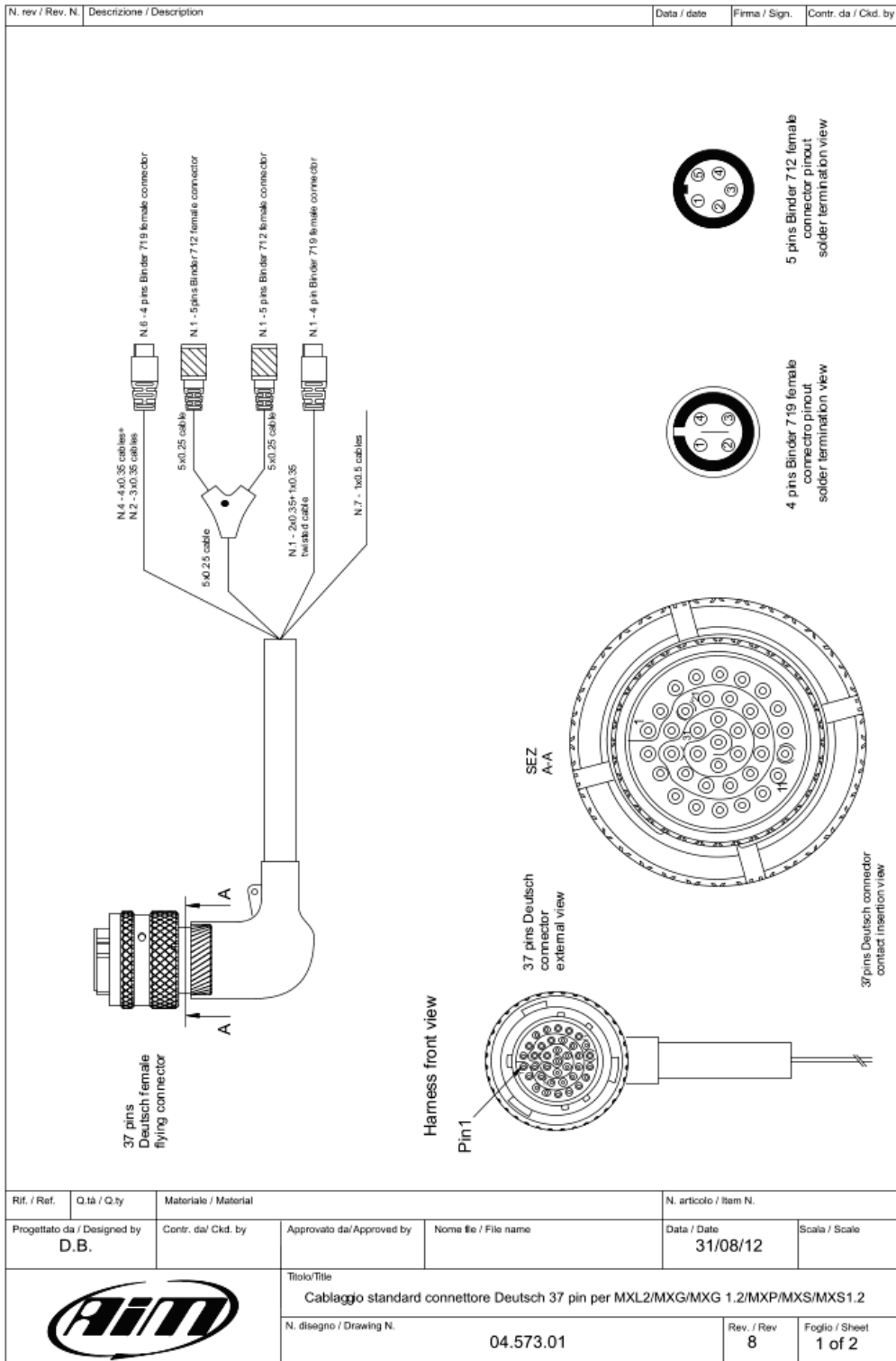

N. rev / Rev. N.	Descrizione / Description	Data / date	Firma / Sign.	Contr. da / Ckd. by
------------------	---------------------------	-------------	---------------	---------------------

Table cables ending with 4 pins Binder 719 female connector						
37 pins Deutsch connector pin	Cable colour	Destination connector pin	Cable type	Length	Channel	Label
22 23 24 25	White Black Red Blue	1 2 3 4	4x0.35mm ²	340mm	Analog channel 1 GND V Battery V Reference	Ch.1
26 27 28 29	White Black Red Blue	1 2 3 4	4x0.35mm ²	340mm	Analog channel 2 GND V Battery V Reference	Ch.2
30 31 32 33	White Black Red Blue	1 2 3 4	4x0.35mm ²	360mm	Analog channel 3 GND V Battery V Reference	Ch.3
34 35 36 37	White Black Red Blue	1 2 3 4	4x0.35mm ²	360mm	Analog channel 4 GND V Battery V Reference	Ch.4
19 20 21	White Black Blue n.c.	1 2 3 4	3x0.35mm ²	320mm	Speed 1 GND V Battery n.c.	speed 1
16 17 18	n.c. Black Blue White	1 2 3 4	3x0.35mm ²	320mm	n.c. GND V Battery Optical lap	Lap
12 14 13	White* Black Blue* n.c.	1 2 3 4	2x0.35+1x0.35 twistato	1100mm	USB D+ GND USB D- n.c.	USB

*= twisted

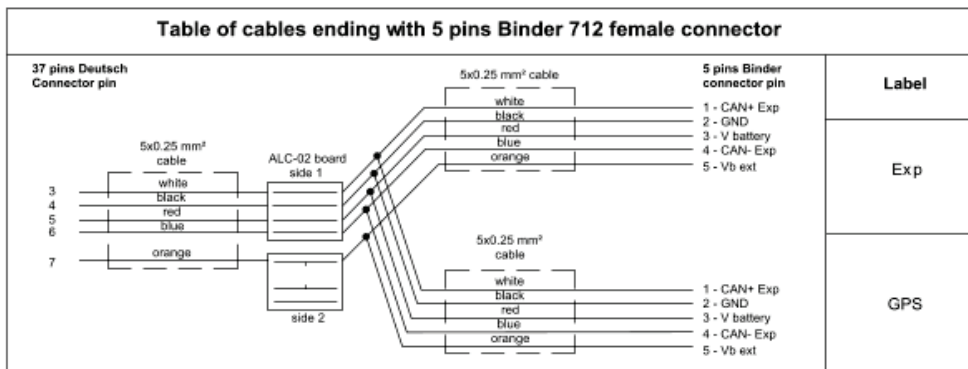
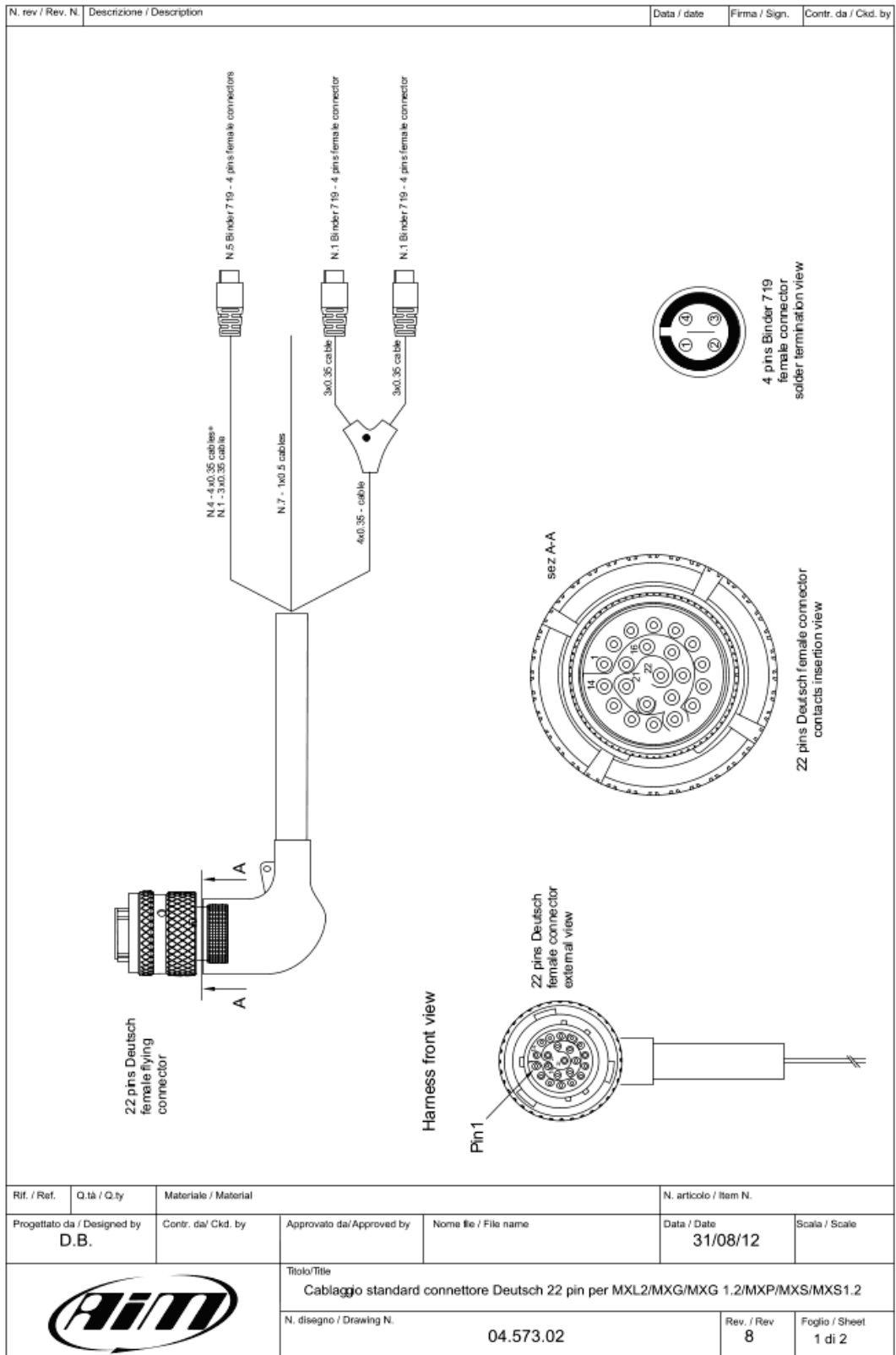

Table of not ended cables				
Connector pin	Cable colour	Cable type	Length	Label
15	white	1x0.5mm ²	550mm	RPM
2 1	black red	1x0.5mm ² 1x0.5mm ²	550mm	GND 9-15V Power input
8 9 10 11	white blue black blue	1x0.5mm ² 1x0.5mm ² 1x0.5mm ² 1x0.5mm ²	550mm	CAN1+ CAN1- K-Line GND K-Line

Rif. / Ref.	Q.tà / Q.ty	Materiali / Material	N. articolo / Item N.	
Progettato da / Designed by D.B.	Contr. da/ Ckd. by	Approvato da/ Approved by	Nome file / File name	Data / Date 31/08/12
		Titolo/Title Cablaggio standard connettore Deutsch 37 pin per MXL2/MXG/MXG 1.2/MXP/MXS/MXS 1.2		
		N. disegno / Drawing N. 04.573.01	Rev. / Rev 8	Foglio / Sheet

22 pins Deutsch connector standard harness



N. rev / Rev. N.	Descrizione / Description	Data / date	Firma / Sign.	Contr. da / Ckd. by
------------------	---------------------------	-------------	---------------	---------------------

Table of cables ending with 4 pins Binder 719 female connector

22 pins Deutsch connector pin	Cable colour	Destination connector pin	Cable type	Length	Channel	Label
1 2 3 4	White black Red Blue	1 2 3 4	4x0.35mm ²	380mm	Analog Channel 5 GND V Battery V Reference	Ch.5
5 6 7 8	White Black Red Blue	1 2 3 4	4x0.35mm ²	380mm	Analog Channel 6 GND V Battery V Reference	Ch.6
9 10 11 12	White Black Red Blue	1 2 3 4	4x0.35mm ²	400mm	Analog Channel 7 GND V Battery V Reference	Ch.7
13 14 15	White Black Red Blue	1 2 3 4	4x0.35mm ²	400mm	Analog Channel 8 GND V Battery V Reference	Ch.8
16 17 18	White Black Blue n.c.	1 2 3 4	3x0.35mm ²	320mm	Speed 2 GND V Battery n.c.	Speed 2

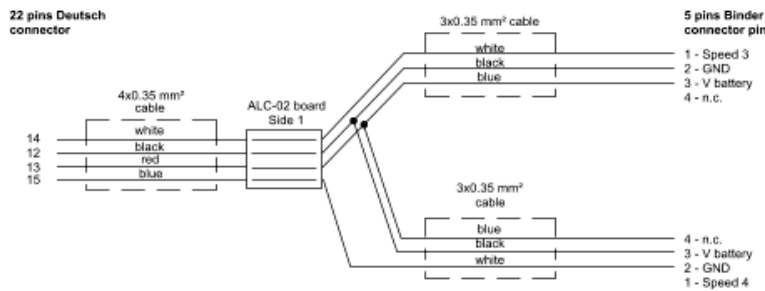
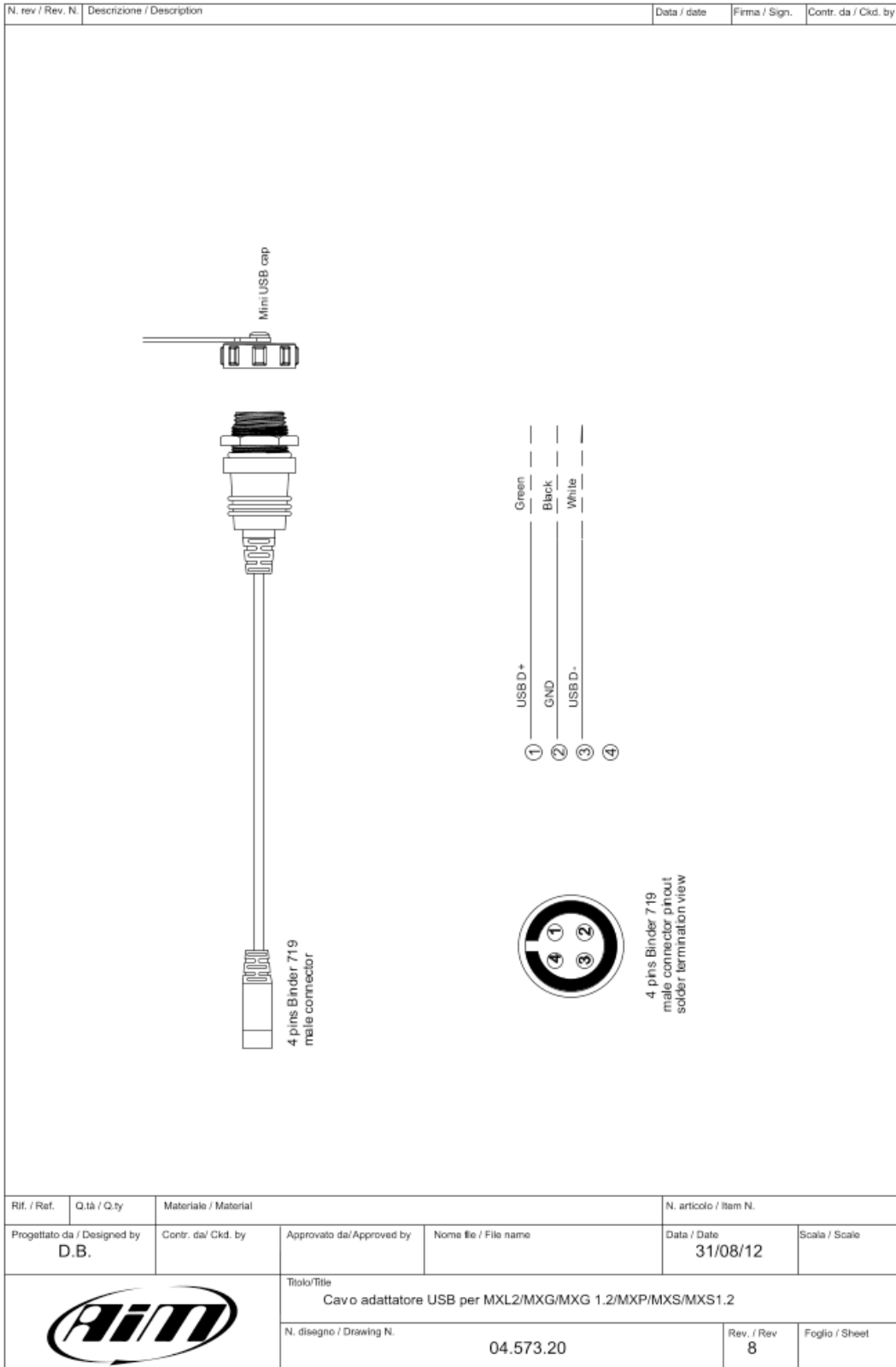

Table of not ended cables

22 pins Deutsch connector pin	Cable colour	Cable type	Length	Label
19 20	bianco blu	1x0.5mm ² 1x0.5mm ²	550mm	Digital output 1 Digital output 2
17 18 16 21 22	bianco blu nero bianco blu	1x0.5mm ² 1x0.5mm ² 1x0.5mm ² 1x0.5mm ² 1x0.5mm ²	550mm	CAN2+ CAN2- GND ECU RS232RX ECU RS232TX

Rif. / Ref.	Q.tà / Q.ty	Materiale / Material	N. articolo / Item N.	
Progettato da / Designed by D.B.	Contr. da/ Ckd. by	Approvato da/ Approved by	Nome file / File name	Data / Date 31/08/12
		Titolo/Title Cablaggio standard connettore Deutsch 22 pin per MXL2/MXG/MXG 1.2/MXP/MXS/MXS1.2		
		N. disegno / Drawing N. 04.573.02	Rev. / Rev 8	Foglio / Sheet 2 di 2

USB cable



MX Series mirror camera connection

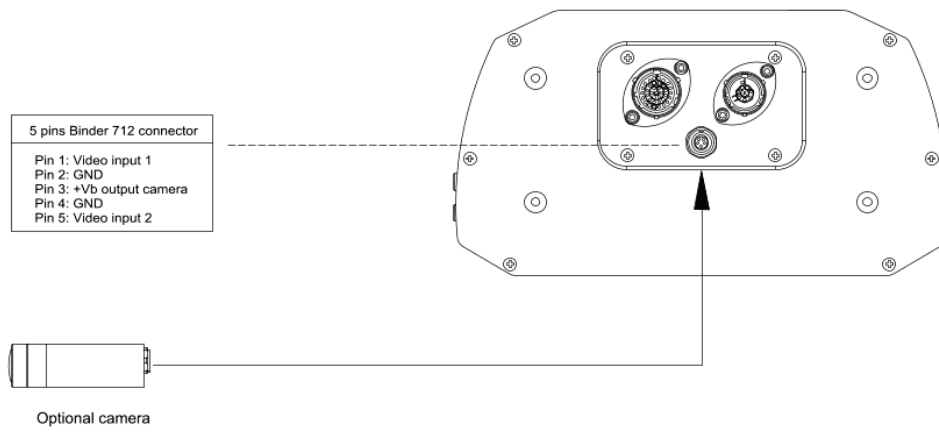

Mirror camera dimensions in mm [inches]

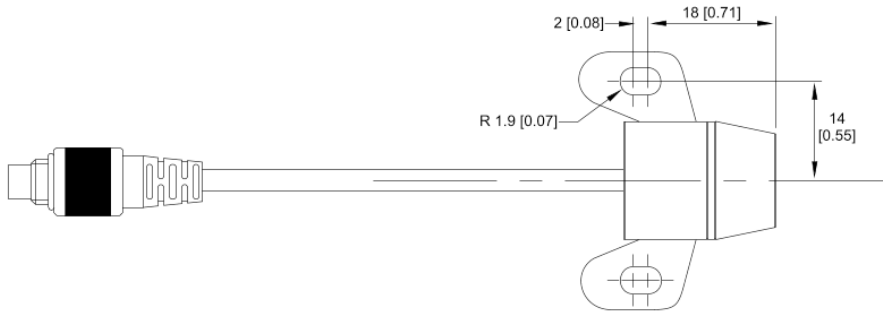
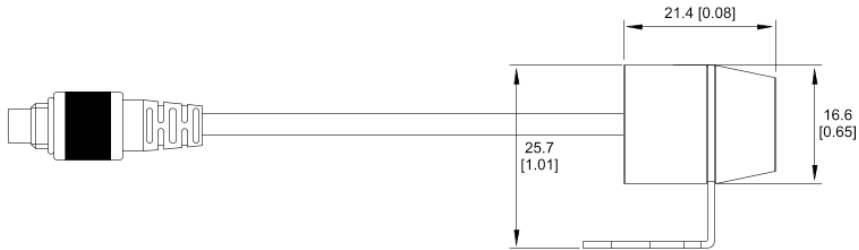

Cable for single rear camera

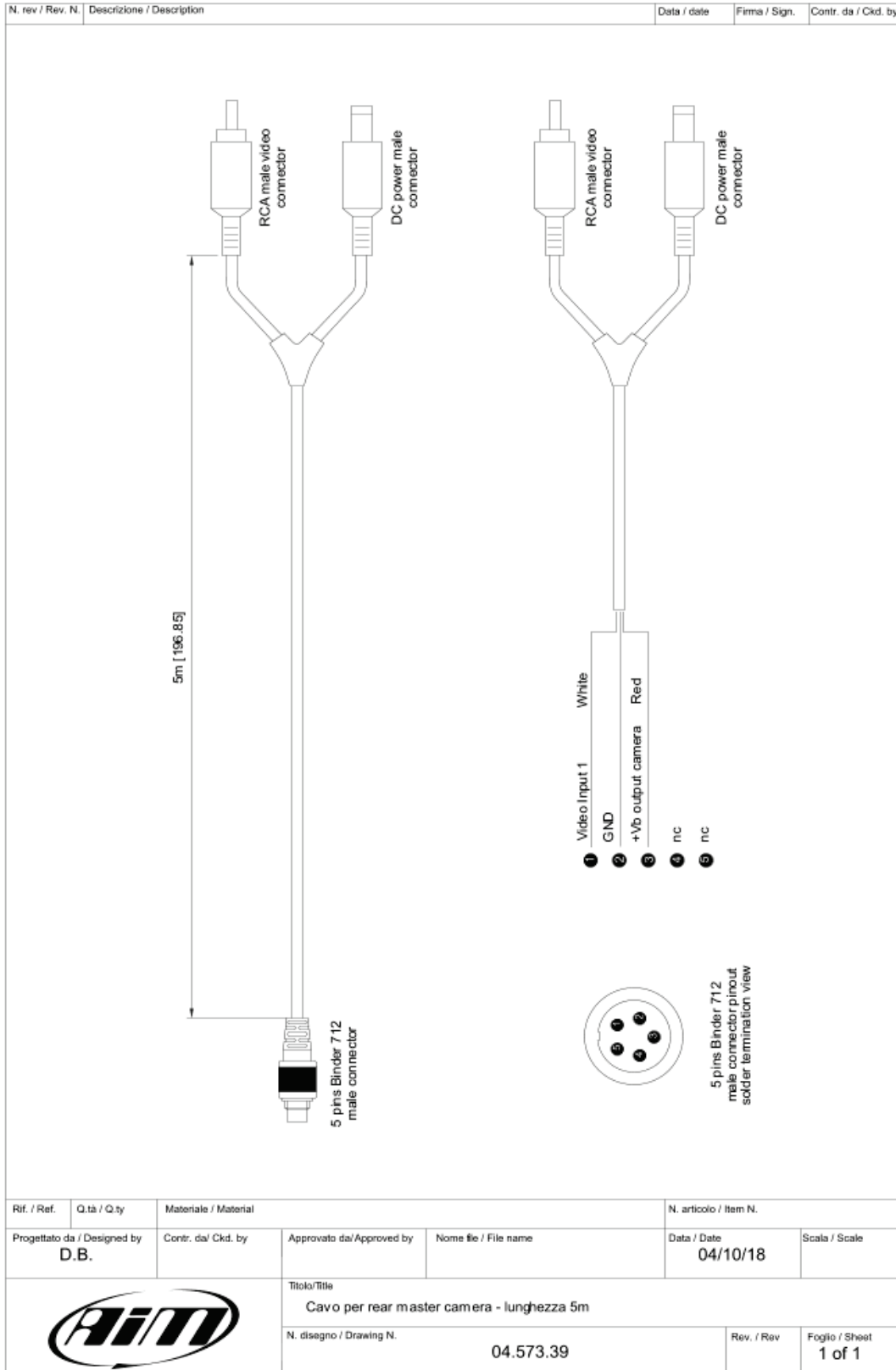

Cable for n.2 rear cameras

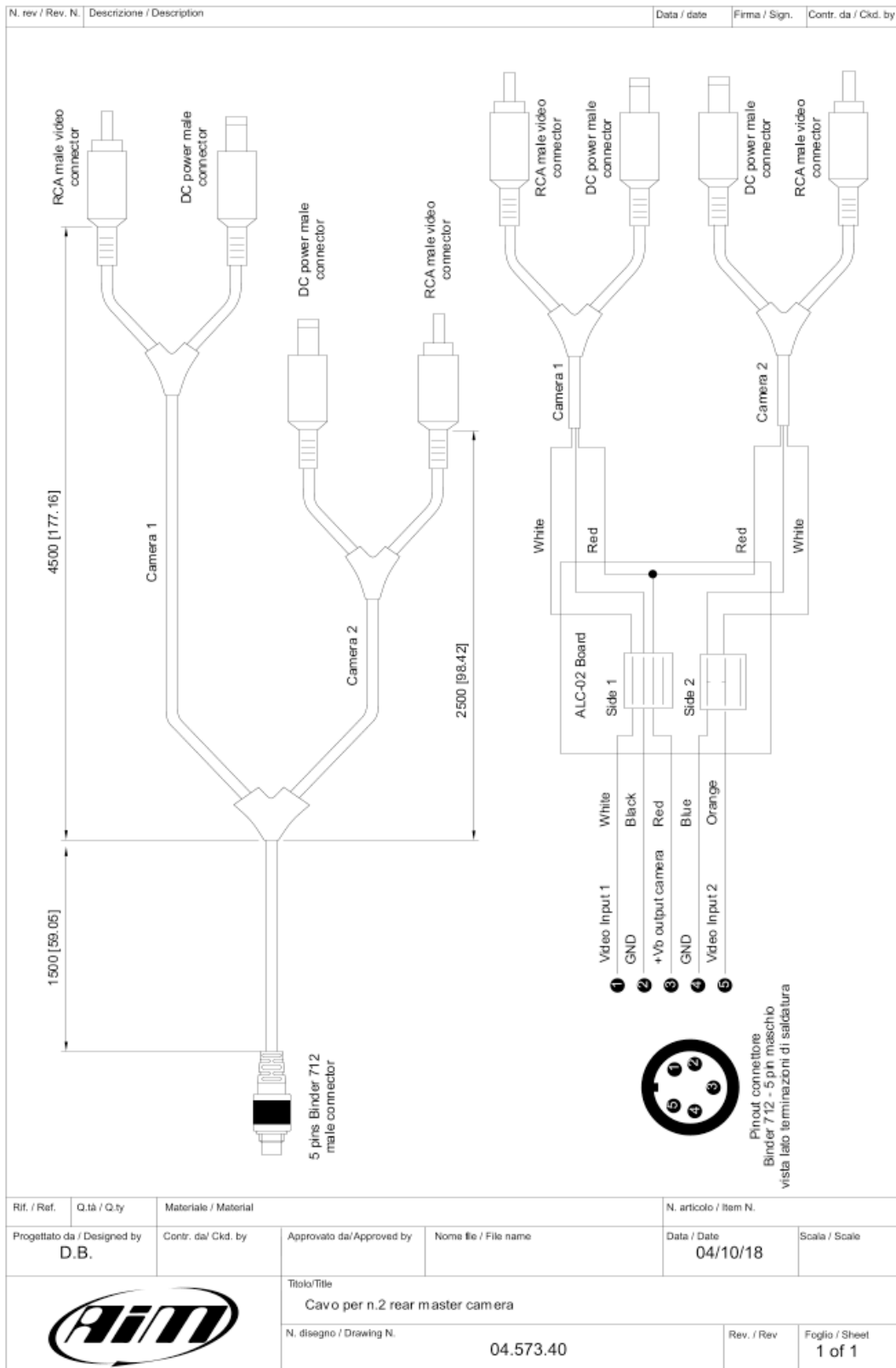

Cable for single AiM mirror camera

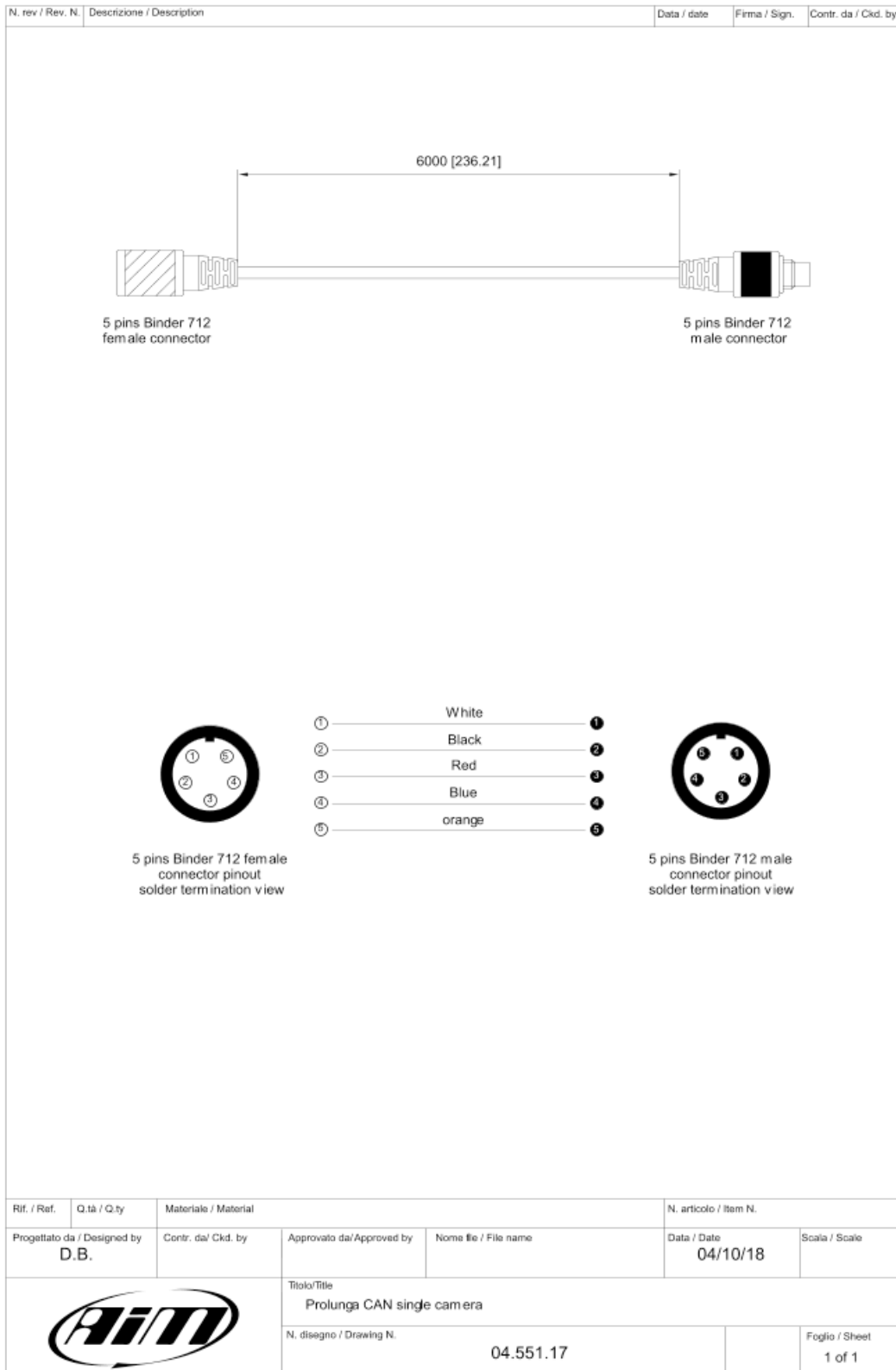

MX Series cable for n.2 AiM mirror cameras

