

User Guide MXm

Release 1.05





INDEX

| | |
|---|----|
| 2 – What is in the kit? | 4 |
| 3 – Installation, powering and accessories | 4 |
| 4 – At power on | 4 |
| 5 – What you can do via keyboard | 5 |
| 5.1 – Power Outputs | 6 |
| 5.2 – Race Mode | 7 |
| 5.3 – Backlight | 7 |
| 5.4 – WiFi | 8 |
| 5.5 – Tracks Management | 9 |
| 5.6 – Counters | 10 |
| 5.7 – Date and Time | 11 |
| 5.8 – Language | 11 |
| 5.9 – System Info | 11 |
| 6 – MXm and the PC | 12 |
| 6.1 – Connection to the PC | 12 |
| 6.1.1 – Wi-Fi configuration | 13 |
| 6.1.2 – Configuring MXm as an access point (AP) | 15 |
| 6.1.3 – Adding MXm to an existing network | 18 |
| 6.1.4 – Wi-Fi network settings | 19 |
| 6.1.5 – The Internet connectivity | 20 |
| 6.1.6 – Connection issues | 20 |
| 6.1.7 – Working on Mac™ with virtualized Windows™ | 21 |
| 6.1.8 – Connected device visualization issues | 24 |
| 6.2 – Configuration of MXm | 24 |
| 6.2.1 – Channels configuration | 25 |
| 6.2.2 – ECU Connection and configuration | 27 |
| 6.2.3 – LCU-One CAN setting | 28 |
| 6.2.4 – Math channels | 29 |
| 6.2.5 – Status variables setting | 30 |
| 6.2.6 – Parameters settings | 31 |
| 6.2.7 – Shift Lights and Alarms | 32 |
| 6.2.8 – Power Outputs setting | 38 |
| 6.2.9 – Display settings | 40 |
| 6.2.10 – SmartyCam stream setting | 42 |
| 6.3 – Managing a track on MXm with Race Studio 3 | 43 |
| 6.4 – ECU Driver builder | 47 |
| 6.5 – The device window | 48 |
| 7 – On the track | 51 |
| 7.1 – Track page | 51 |
| 7.2 – Other pages | 51 |
| 8 – Data recall | 52 |
| 9 – Data download | 54 |
| 10 – Data Analysis | 55 |
| 11 – New firmware upgrade | 57 |
| 12 – RPM | 58 |
| 12.1 – RPM from ECU | 58 |
| 12.2 – RPM via a 5-50V square wave or coil (150-400V) | 58 |
| 13 – Connection with SmartyCam and LCU-One | 61 |
| 14 – Technical specifications and drawings | 63 |



1 – MXm in a few words

What is MXm?

MXm is the new AiM mini logger that combines small dimensions, usability and logging capability.

Why MXm?

Because it features:

- ECU connection
- 2 speed inputs
- 4 analog inputs
- 2 digital high side output
- up to 8 configurable display pages
- integrated GPS + Glonass receiver
- a huge tracks database to automatically select the track you are racing on
- a powerful and comfortable Wi-Fi connection
- 10 RGB LEDs that clearly show if you are improving or not
- a huge amount of internal memory (four gigabytes) capable of recording a lot of tests

What about ECU connection?

MXm manages all the hardware ECU connections as well as all the communication lines: CAN, K-Line, RS232. Its huge database includes more than 1500 protocols you can load in your MXm.

If the vehicle does not have an ECU?

In case your vehicle does not have an ECU, you can anyway connect MXm to an RPM wave to synchronize RPM to the position on the track thanks to the cable labelled RPM of 37 pins connector harness you find in the kit.

Is MXm an expandable logger?

Yes. MXm can be connected to AiM LCU-One CAN to maximize your engine performances and AiM SmartyCam to see your track performances on your PC with all the values you need in overlay.

2 – What is in the kit?

MXm kit includes:

- MXm
- 37 pin connector harness (**V02573310**)
- 4 pins connector kit (**X87KCDTP064S**)
- USB cable (**V02573200**)
- MXm user manual

The part numbers indicated above are to be used to buy single items.

3 – Installation, powering and accessories

MXm is powered connecting the 37 pins connection harness you find in the kit to the vehicle master switch. This way MXm will switch on/off with the vehicle engine.

37 pins connection harness wires to be used are labelled “9-15 VDC” and “GND”.

As said before, AiM MXm features two digital outputs you can turn ON/OFF according to pre-defined conditions you can set using Race Studio 3 software. They need

the connection of the 4 pins connector included in the kit. Please refer to MXm pinout you find at the end of this user manual for further information.

4 – At power on

When switched on MXm shows satellite page.

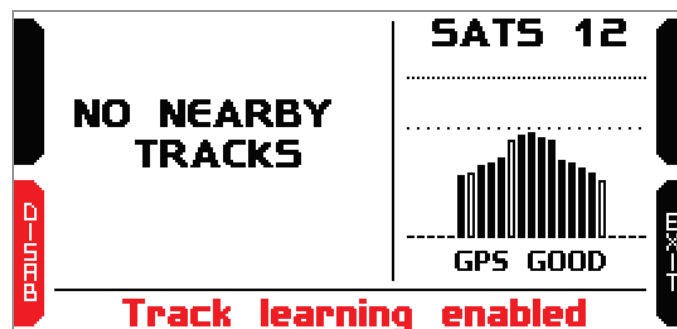

Here you can see the number of connected satellite (SATS 12 in the image above) as well as the quality of the signal.

If you are on a track not included in MXm database the system shows the message “NO NEARBY TRACKS and “Track learning” enables automatically. You can disable it pressing the related button, that switches to “ENABLE” and you only need to press it again to enable track learning mode. In this second case the system asks for confirmation.

Please refer to “Tracks Management” chapter for further information.

5 – What you can do via keyboard

MXm is mainly configurable using Race Studio 3 software but some functions are settable via keyboard as explained here below. Press "MENU" and this page shows up.

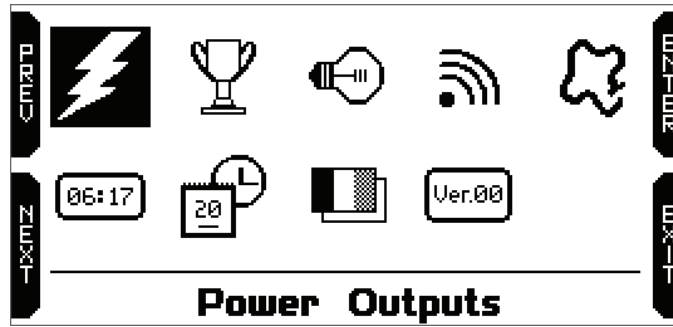

The icons are to manage:



Power Outputs



Wi-Fi settings



Date and Time



Type of Race



Tracks

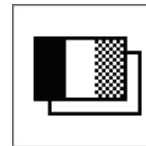

Language



Backlight



Counters



System Info



5.1 – Power Outputs

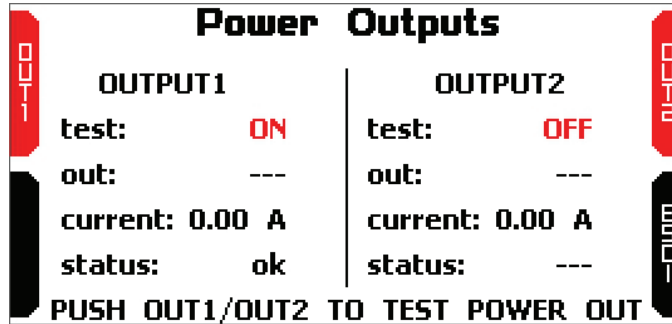

In this page you can test MXm Power Outputs.

Pressing “OUT1” e “OUT2” the related tests switch from ON to OFF and vice-versa.

The bottom row shows output status; it can be “OK” or show one of the messages indicated in “Legend of Status Values” table shown here below; table you can find bottom of the panel “Modify output signal” that shows up pressing the setting icon in “Power Outputs” layer of MXm configuration (see paragraph 6.2.8 for further information).

Legend of Status Values:

| Value | 0 | 1 | 2 | 4 | 8 | 16 | 32 |
|-------------|----|---------------|--------------|------------------|--------------|---------------|--------------|
| Label | ok | sc | open | htemp | ovcur | unvol | ovvol |
| Description | ok | short circuit | open circuit | high temperature | over current | under voltage | over voltage |



5.2 – Race Mode

MXm features two race mode and two reference mode to compute predictive lap time. Available race mode are:

- Speed
- Oval

Predictive lap time shows the lap time gap between the current predictive lap time and a lap time used as reference one. Available reference laps are:

- Best Lap of the test
- Best Lap of Today

Use:

- “CHANGE” to modify the setting
- “PREV” and “NEXT” to witch from one option to the other
- “EXIT” to save and exit



5.3 – Backlight

You can set MXm backlight as “AUTO” (Default setting), “ON” or “OFF”.

Thanks to the light sensor, placed left front of MXm, “AUTO” setting switches the backlight on/off according to the ambient light conditions.

MXm backlight can be: white, purple, red, green, yellow, blue and cyan.





5.4 – WiFi

Here you can manage Wi-Fi as well as reset its configuration. **Wi-Fi modes** are:

- ON
- Auto: switches Wi-Fi on when the vehicle is stopped and automatically switches it off when MXm starts recording, according to the setting you performed in “Parameters” page of Race Studio 3 software (see paragraph 6.2.6 for further information)
- OFF

“**Wi-Fi reset CFG**” allows you to reset Wi-Fi configuration and is very useful if you do not remember Wi-Fi password.

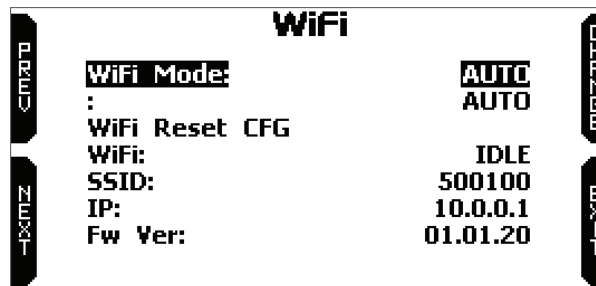



5.5 – Tracks Management

MXm built in GPS receiver is used for:

- Lap time calculation
- Speed calculation
- Predictive lap time calculation
- Position on the track in analysis

To calculate these data the system needs to know the start/finish line coordinates.

MXm comes with a long list of the world main tracks. The list is constantly updated by our technicians and it updates on your PC when you run Race Studio 3 software and a connection to the internet is available. Available track selection modes are: automatic and manual.

Automatic:

the system automatically recognizes the track you are running on, loads start/finish line and calculates lap times. This is the best mode in most cases.



Manual:

allows you to manually select the track from the internal database.

This mode is to be preferred when multiple track configurations are available nearby. In this case MXm would anyway recognize the track but would need at least one complete track lap.

To be ready from the first lap manual mode would be helpful.

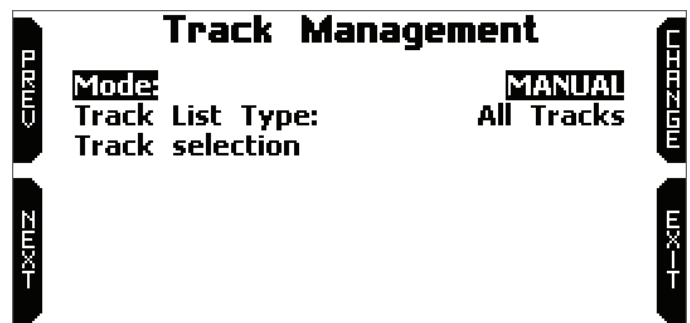

Both track modes provide three track list type:

- nearest: shows only tracks in a 10 km distance with max 50 tracks shown
- all tracks: shows all tracks stored in the system in alphabetical order
- custom: shows only the tracks you have previously created with Race Studio 3 software (see paragraph 6.3)

5.6 – Counters

This page manages the 4 resettable odometers of MXm. The system odometer is not resettable. All odometers are shown on Race Studio 3 too (see chapter 6 “MXm and the PC”).

| COUNTERS | | |
|----------|-------|---------|
| System: | 00:83 | 147 km* |
| Usr 1: | 00:23 | 47 km* |
| Usr 2: | 00:41 | 87 km* |
| Usr 3: | 00:12 | 27 km* |
| Usr 4: | 00:30 | 57 km* |

Each odometer can be activated/deactivated and/or reset. To select the odometer you want to manage press “CHANGE”.

- scroll to Status and press “CHANGE” to switch from “Active” to “Stop” and vice-versa
- scroll to clear and press “CHANGE” to reset an odometer (left image below)
- pressing “EXIT” you come back to odometer page and the odometer you stopped/reset will not show the asterisk and will show “0” km (in the example below both operations have been performed on odometer 1 (right image below)).

| Counters | | |
|----------|-------|--------|
| Usr 1: | 00:23 | 47 km |
| Status: | | Active |
| Clear | | |

| COUNTERS | | |
|----------|-------|---------|
| System: | 00:83 | 147 km* |
| Usr 1: | 00:23 | 0 km |
| Usr 2: | 00:41 | 87 km* |
| Usr 3: | 00:12 | 27 km* |
| Usr 4: | 00:30 | 57 km* |



5.7 – Date and Time

Here you can:

- set the time zone of MXm: press “ENTER” (left image below), scroll up to the desired time zone and press “EXIT”
- enable/disable “Daylight Saving Time” and set time and date format: press “CHANGE” to set and “EXIT” to save and quit.

While “Time zone” is always set manually, Time is automatically synchronized as MXm receives the GPS signal.

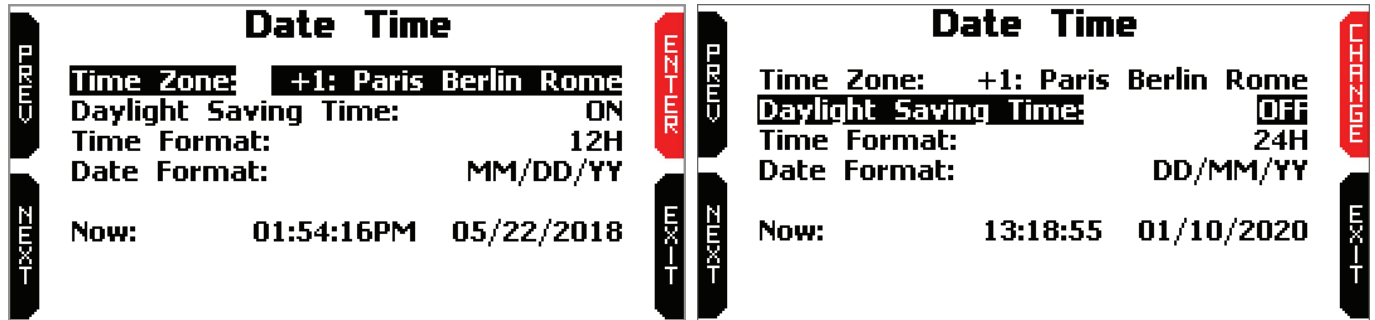

5.8 – Language

You can set MXm language. Default setting is English. Press “CHANGE” to set the language you prefer. At present available languages are (in this order):

- English
- Italian
- German
- Spanish
- French
- Dutch
- Danish
- Portuguese
- Japanese
- Czech



5.9 – System Info

This page shows serial number as well as firmware and boot version of your MXm.

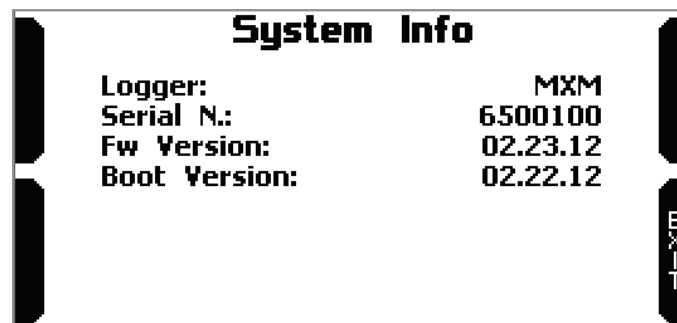

6 – MXm and the PC

Using AiM Race Studio 3 software you can configure MXm, manage its tracks database as well as check other device functions using the software device window.

6.1 – Connection to the PC

MXm can be connected to the PC via Wi-Fi or via USB.

To connect MXm to the PC **via USB** use the USB cable you find in the kit; plug it in the cable labelled “USB” of MXm 37 pins connector harness and in the PC USB port.

To connect MXm to the PC via **Wi-Fi**:

- check that MXm Wi-Fi is set on “AUTO” or on “ON”
- read your MXm name – mid of MXm home page bottom line – or look for it in system information page
- click Race Studio 3 Wi-Fi icon and select your MXm
- press “Connect” and wait just a few moments.

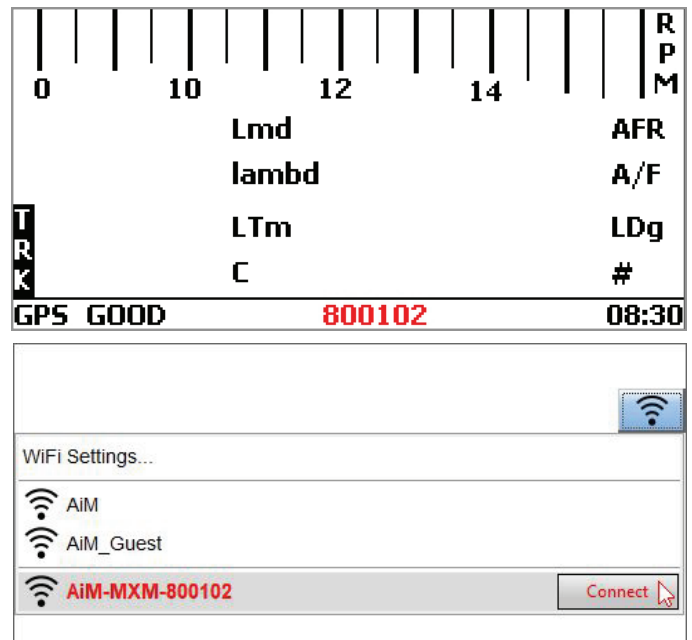

Once the system is connected to the PC the software shows it bottom left of the software home page showing also the way it is connected: USB or Wi-Fi as shown here below.

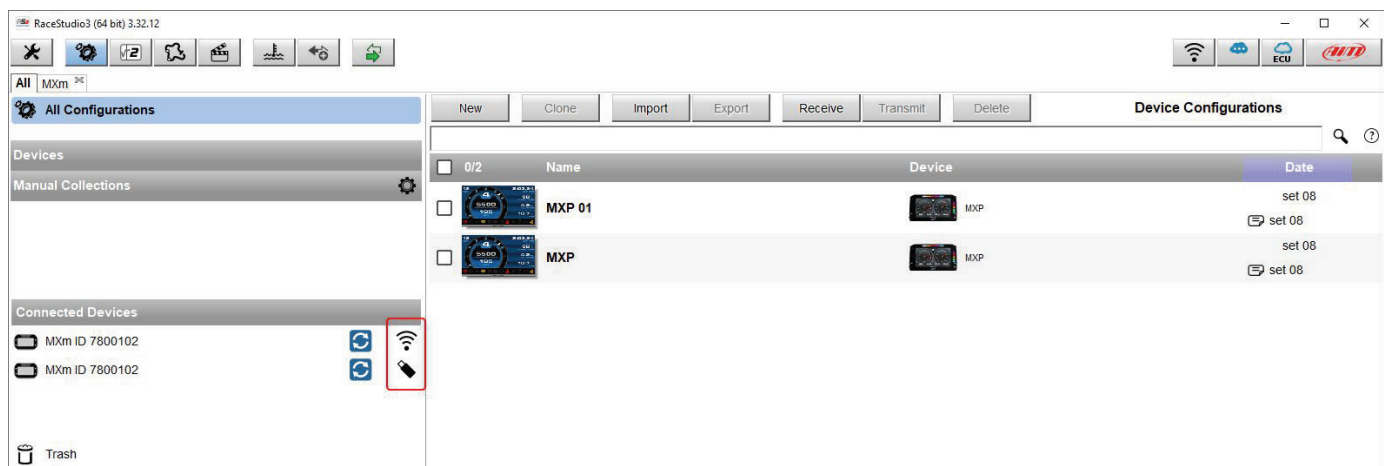

6.1.1 – Wi-Fi configuration

As far as Wi-Fi connection is concerned two possible Wi-Fi modes are available.

1 – As an access point (AP – default)

This is the ideal configuration if you have one only device and one only computer. In this situation your MXm creates a Wi-Fi network and works as an Access Point you can connect your PC to.



2 – Existing network (to connect to an existing Wi-Fi network – WLAN)

This mode is complex and implies an external access point (AP) but it is also more flexible and powerful because allows you to communicate with more than one device and with more than one computer in the same network. MXm and the PC must connect to an existing Wi-Fi network made by a device that works as an external access point.

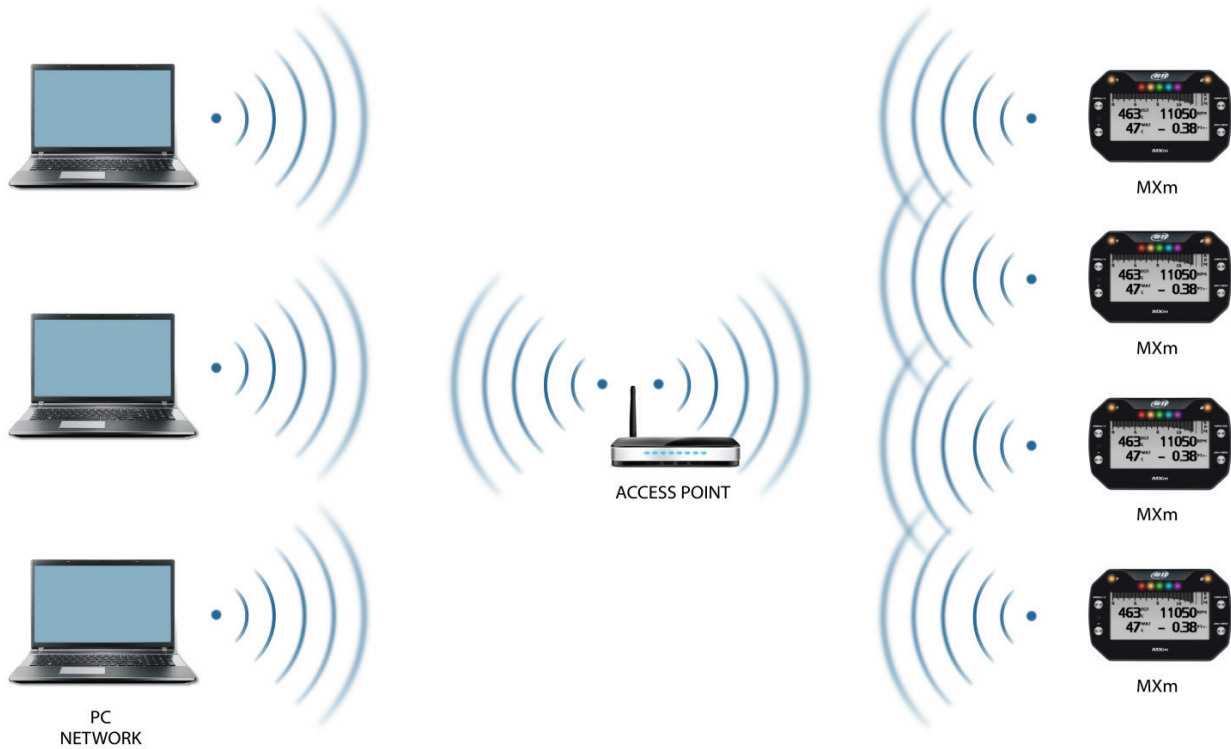

When working in WLAN mode MXm has two available security levels:

- network authentication: network password
- device authentication: MXm password

Both levels allow you to use different strategies. A PC in WLAN, for example, can see several AiM devices but can communicate only with those he knows the password of.

If you forget the password you can reset Wi-Fi configuration from MXm menu as explained before.

6.1.2 – Configuring MXm as an access point (AP)

This is MXm default configuration and is the easiest and most direct connection mode, ideal if you want to communicate with one MXm using one PC. It is free and so completely accessible by anyone. Please set an access password as soon as possible.

To establish a Wi-Fi connection:

- ensure that the Wi-Fi is enabled
- read your MXm Name

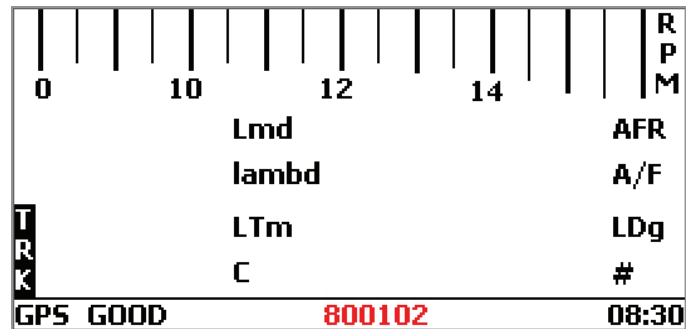

- run Race Studio 3
- click Wi-Fi icon and select your device
- in a few seconds the connection is established





To set other parameters create a unique password to protect your device/your network. With a password the communication is safe and encrypted using WPA2-PSK standard.

Characters allowed in the password are all letters, also capital, all digits and these characters: '+_[]{}\$£!/?^#@*\\"=~.:/%"

"Space" type can be used if it is not the first one because this could cause incomprehension in some Windows™ versions.

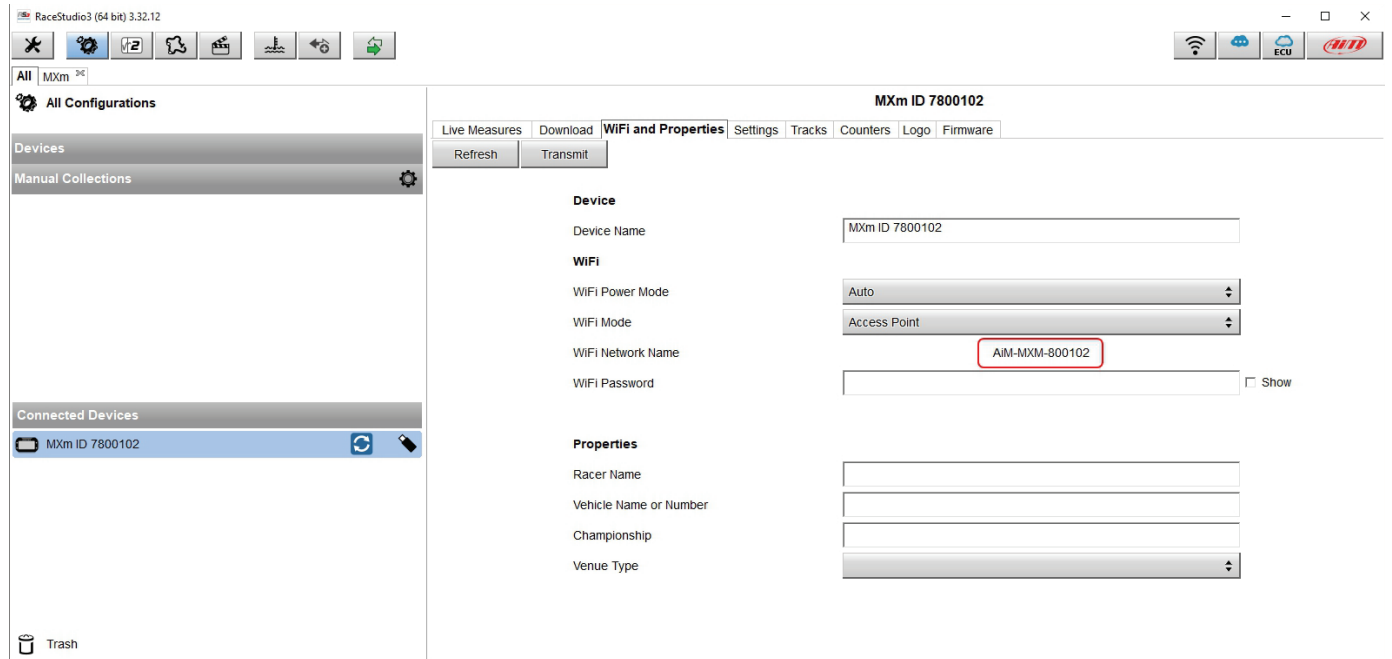

This AP or SSID name is unique for your device.

An example of name is: "AiM-MXM-00100" where:

- "AiM" is the prefix of all AiM devices
- "MXm" is the device identifier
- "00100" is your device serial number assigned by the factory.

To make your device more recognizable you can add a name to the SSID. The limit is of eight characters. Allowed characters are all letters, capital too, all digits and these characters: '+ - _ () [] {}!.

“Space” type can be used provided that it is not the first one because it can cause incomprehension in some Windows™ versions.

If, for example, you add the driver’s name, Tom Wolf, the network name (SSID) becomes:

“AiM-MXM-00100-TomWolf”

Once all parameters set click “Transmit”. MXm reboots and is configured with the new parameters. If MXm is protected by a password, as recommended, Race Studio 3 will ask that password to authenticate.

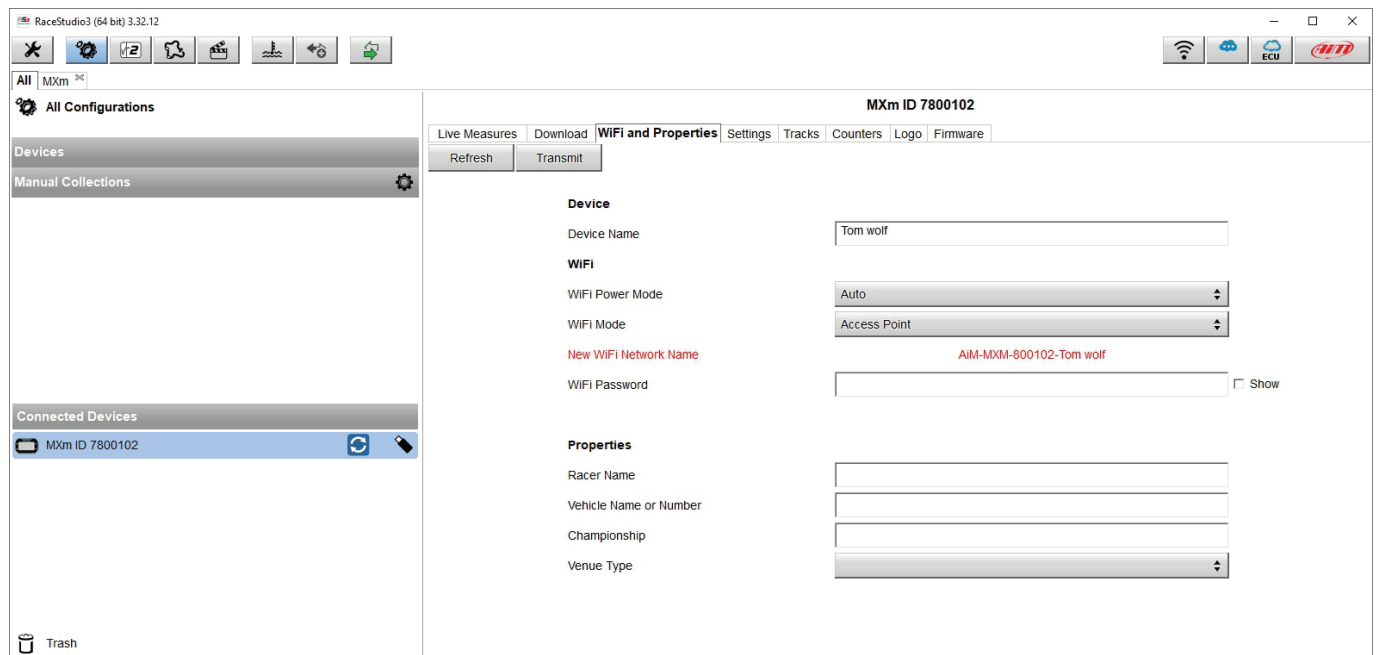

Please Note: the same Wi-Fi connection can be created with the operative system tool.

Once the device has been authenticated in the Wi-Fi network you can communicate with it using Race Studio 3.

6.1.3 – Adding MXm to an existing network

This situation is ideal for a team with multiple drivers and staff members and is desired to communicate with one or more AiM devices using the same PC network. Each MXm can have its password that adds another security and privacy level to the network. Race Studio 3 will show all devices connected to the same network under “Connected devices” label, bottom left of the software page: click your device.

Enter “Wi-Fi and properties” tab and set it on “Existing Network”; fill in network name, network password and device password. Transmit the network settings to your device clicking “Transmit”; your device reboots and joins that network.

Please note: the only admitted password are those following WPA2-PSK standard. To complete this procedure use Race Studio 3 software as here explained.

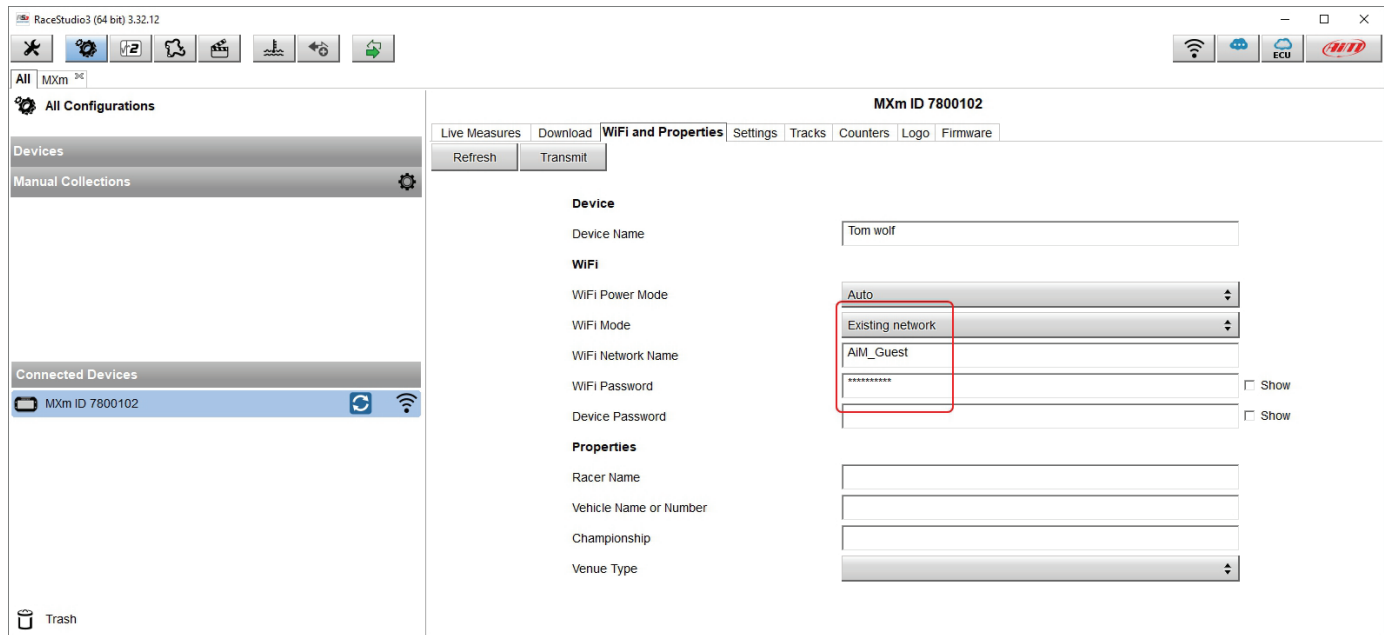

Here above you see a device “MXm ID 6500100” that switched from AP to WLAN mode (Existing Network). Network name is “AiM” and does not work with free access because is protected by a password. To obtain connectivity on the device the PC has to be authenticated to the same network as shown here below.

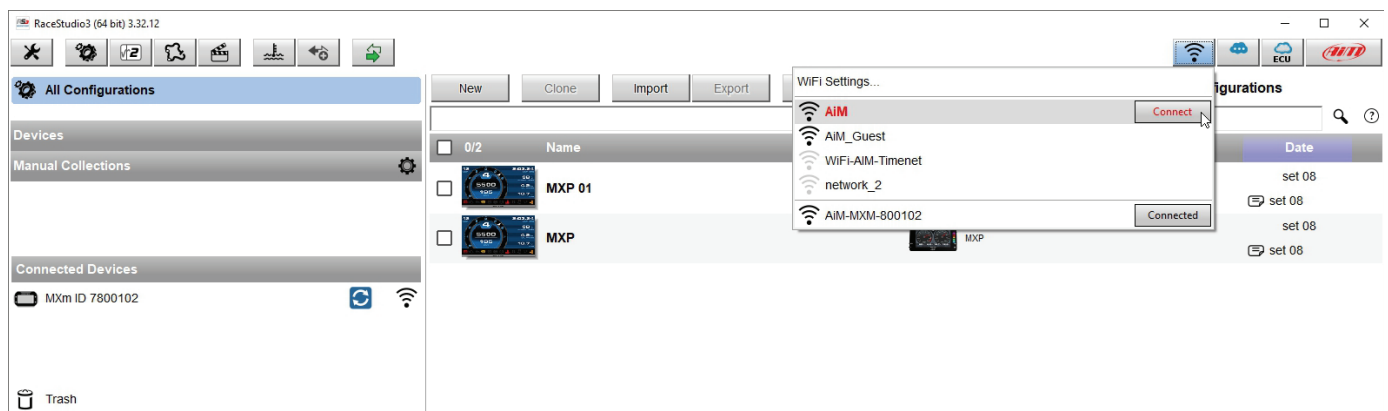

When the PC is authenticated to the network called "AiM" it can see all devices you configured to access the same network. In the image below three AiM devices are connected to the same "AiM" WLAN.

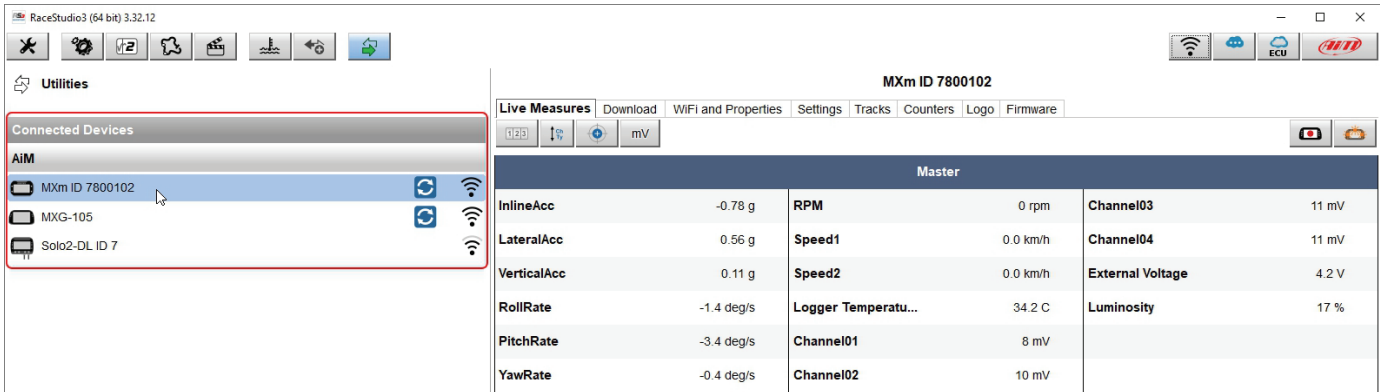

6.1.4 – Wi-Fi network settings

In this chapter you find a short description of how to configure a WLAN including AiM devices and a PC. Here below is an example of configuration.

ROUTER SETTINGS

Use this section to configure the internal network settings of your router. The IP Address that is configured here is the IP Address that you use to access the Web-based management interface. If you change the IP Address here, you may need to adjust your PC's network settings to access the network again.

Router IP Address :
Subnet Mask :
Device Name :
Local Domain Name : (optional)
Enable DNS Relay :

DHCP SERVER SETTINGS

Use this section to configure the built-in DHCP Server to assign IP addresses to the computers on your network.

Enable DHCP Server :
DHCP IP Address Range : to
DHCP Lease Time : (minutes)
Always Broadcast : (compatibility for some DHCP Clients)
NetBIOS announcement :
Learn NetBIOS from WAN :
NetBIOS Scope : (optional)
NetBIOS node type :
 Broadcast only (use when no WINS servers configured)
 Point-to-Point (no broadcast)
 Mixed-mode (Broadcast then Point-to-Point)
 Hybrid (Point-to-Point then Broadcast)
Primary WINS IP Address :
Secondary WINS IP Address :

For better network performances, we suggest the use of a network device equipped with a DHCP server and using 3x3 MIMO technology like, for example a Linksys AS3200.

To maximize the bandwidth, you should not allow the Internet on this WLAN; this means the DHCP server should be configured without any DNS address nor gateway by default.



The parameters for the device network configuration in this example are:

- **Wireless network name: Network_1**
It means that the WLAN network name is "Network_1." A PC has to be authenticated in this network to interact with any AiM device of this network.
- **Gateway address: 192.168.0.1**
primary DNS server: 0.0.0.0
secondary DNS server: 0.0.0.0
(These settings prevent Internet connectivity on this WLAN.)
- **Subnet mask: 255.255.255.248**
Enable DHCP server: yes
DHCP IP address range: 192.168.0.2 to 192.168.0.6

These settings enable a DHCP server running on this WLAN and provide an IP address in a 2-6 range. This means that this network allows 5 network hosts.

The number of devices on a WLAN network depends on the subnet mask. Here below you see typical examples of network masks and IP addresses range.

The configuration in bold is the one we suggest (if a greater number of devices is not needed), being the one that makes it easier and quicker for Race Studio 3 the identification of the devices in the network.

| Subnet mask: | IP address range: | Number of devices: |
|------------------------|------------------------|--------------------|
| 255.255.255.0 | 192.168.0.1 – 254 | 254 |
| 255.255.255.128 | 192.168.0.1 – 126 | 126 |
| 255.255.255.192 | 192.168.0.1 – 62 | 62 |
| 255.255.255.224 | 192.168.0.1 – 30 | 30 |
| 255.255.255.240 | 192.168.0.1 – 14 | 14 |
| 255.255.255.248 | 192.168.0.1 – 6 | 6 |

6.1.5 – The Internet connectivity

For an optimal speed of your AiM device(s) we recommend not to allow the Internet on the same network and to set the WLAN in the same way.

You can of course allow the Internet access on your network but this would degrade the communication.

This slightly slower speed can be suitable for your needs but you can also have a second Wi-Fi connection using an additional hardware (NIC).

This configuration would provide an optimal speed of the data network of your AiM device(s) and at the same time would provide an internet connectivity with the second NIC.

6.1.6 – Connection issues

It can occur that MXm is correctly connected to Race Studio 3 via Wi-Fi but the software user interface does not show it. This may be because Wi-Fi port setting is set with a static IP. To switch it to dynamic (DHCP):

- open "Network and sharing centre" in the Windows™ research engine
- click on the Wi-Fi connection and a panel shows up
- select "Properties" option
- double click on "Internet Protocol version 4 (TCP/IPv4)"
- verify that option "Obtain an IP address" is active

For further information refer to FAQ section, Wi-Fi of www.aim-sportline.com.

6.1.7 – Working on Mac™ with virtualized Windows™

Race Studio 3 only works on Windows™ operative systems; Mac users can use a virtualized Windows™ machine.

The main problem is that the host OS (Mac) must share its Wi-Fi interface with the virtualized operative system (Windows) as Ethernet interface and not as Wi-Fi interface.

Configuring Parallels(™)

Select “Menu -> Configure...” in Parallels.

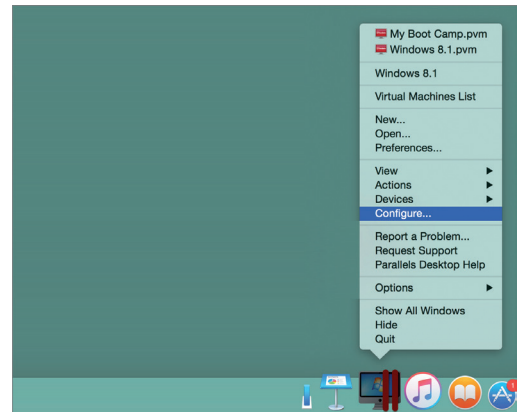

Press “Hardware” – top on the page that shows up – and select “Network” in the menu on the left.

Right on the configuration panel set "Type" field on “Wi-Fi”. Then select the device you want to communicate with.

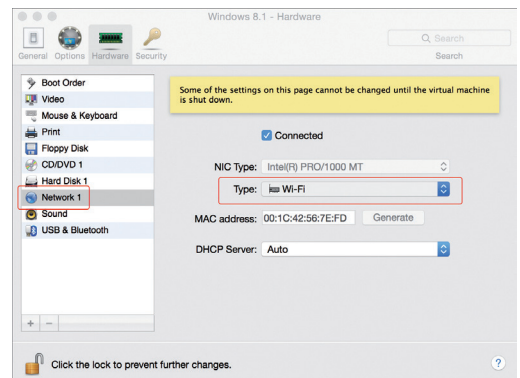

To ensure that the communication works select “Open Network preferences...” menu.



Verify that the status in the window that shows up is “Connected” and that the IP address associated is, for example, 10.0.0.10 (could be 10.0.0.11, 10.0.0.12, or generically 10.0.0.x).

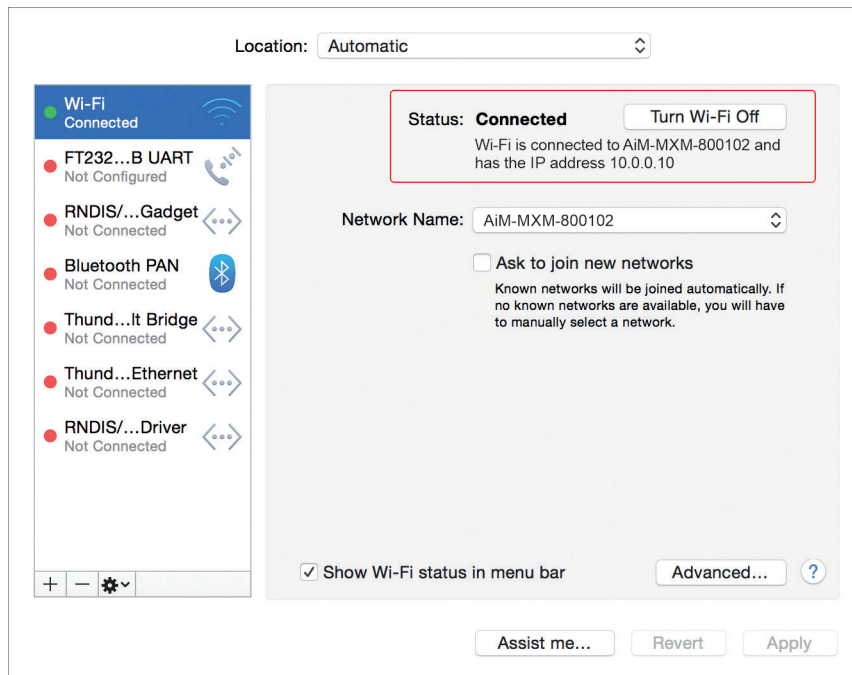

To enable Race Studio 3 correctly working on a Mac with virtualized Windows™.

- press Wi-Fi icon
- select "Wi-Fi Settings" option

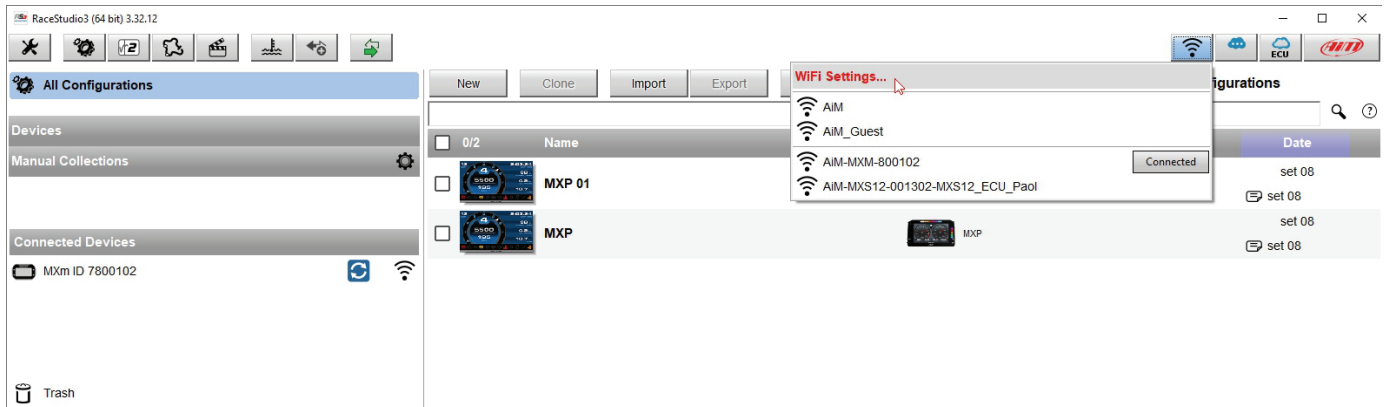

- enable the checkbox shown here below.



6.1.8 – Connected device visualization issues

It may occur that using Race Studio 3 on an iMac with virtualized Windows the device connected via Wi-Fi takes some time to be shown in the network or is not shown at all. This is why we always suggest using an Wi-Fi (WLAN) router.

This router work as an Access Point allowing more external devices to connect to its network. MXm Wi-Fi configuration is to be set on Existing Network as explained before.

6.2 – Configuration of MXm

Once MXm connected to the PC

- click “Configurations” icon and configurations page appears
- click “New” and new configuration panel appears: select “MXm” and press “OK”.

The screenshot displays the RaceStudio3 (64 bit) 3.32.12 application window. The main interface shows a toolbar with icons for various functions and a menu bar. The 'All Configurations' page is active, displaying a list of devices under 'Last Configured Devices' and 'All Devices'. The 'MXm' device is highlighted with a red box. A 'Choose Your Device' dialog box is open, showing the 'MXm' device selected. To the right, the 'Configuration Name and Notes' dialog box is open, showing the configuration name 'MXm' and a comment field. The 'OK' button is highlighted with a red mouse cursor.

6.2.1 – Channels configuration

“Channels” layer opens; all logger channels are disabled by default. Here you can set all MXm channels.

| ID | <input checked="" type="checkbox"/> | Name | Function | Sensor | Unit | Freq | Parameters |
|------|-------------------------------------|--------------|----------------|----------------------------|-----------|-------|---------------------------|
| RPM | <input checked="" type="checkbox"/> | RPM | Engine RPM | RPM Sensor | rpm | 20 Hz | max: 16000 ; factor: /1 ; |
| Spd1 | <input type="checkbox"/> | Speed1 | Vehicle Spd | Speed Sensor | km/h 0.1 | 20 Hz | wheel: 1600 ; pulses: 1 ; |
| Spd2 | <input type="checkbox"/> | Speed2 | Vehicle Spd | Speed Sensor | km/h 0.1 | 20 Hz | wheel: 1600 ; pulses: 1 ; |
| Ch01 | <input type="checkbox"/> | Channel01 | Voltage | Generic 0-5 V | mV | 20 Hz | |
| Ch02 | <input type="checkbox"/> | Channel02 | Voltage | Generic 0-5 V | mV | 20 Hz | |
| Ch03 | <input type="checkbox"/> | Channel03 | Voltage | Generic 0-5 V | mV | 20 Hz | |
| Ch04 | <input type="checkbox"/> | Channel04 | Voltage | Generic 0-5 V | mV | 20 Hz | |
| Acc1 | <input checked="" type="checkbox"/> | InlineAcc | Inline Accel | AIM Internal Accelerometer | g 0.01 | 50 Hz | |
| Acc2 | <input checked="" type="checkbox"/> | LateralAcc | Lateral Accel | AIM Internal Accelerometer | g 0.01 | 50 Hz | |
| Acc3 | <input checked="" type="checkbox"/> | VerticalAcc | Vertical Accel | AIM Internal Accelerometer | g 0.01 | 50 Hz | |
| Gyr1 | <input checked="" type="checkbox"/> | RollRate | Roll Rate | AIM Internal Gyro | deg/s 0.1 | 50 Hz | |
| Gyr2 | <input checked="" type="checkbox"/> | PitchRate | Pitch Rate | AIM Internal Gyro | deg/s 0.1 | 50 Hz | |
| Gyr3 | <input checked="" type="checkbox"/> | YawRate | Yaw Rate | AIM Internal Gyro | deg/s 0.1 | 50 Hz | |
| Accu | <input checked="" type="checkbox"/> | GPS Accuracy | GPS Accuracy | AIM GPS | m 0.01 | 10 Hz | |
| Spd | <input checked="" type="checkbox"/> | GPS Speed | Vehicle Spd | AIM GPS | km/h 0.1 | 10 Hz | |
| Alt | <input checked="" type="checkbox"/> | Altitude | Altitude | AIM GPS | m | 10 Hz | |
| OdD | <input checked="" type="checkbox"/> | Odometer | Odometer Total | AIM ODO | km 0.1 | 1 Hz | |
| Luma | <input checked="" type="checkbox"/> | Luminosity | Brightness | AIM Luminosity | % | 1 Hz | |

To set a channel just click on its line and the related panel shows up. Speed 1 and 2 and the four Analog channels are disabled by default. First thing to do is enabling them.

To set **Speed** channels click on the row and a setting panel appears. In addition to sampling frequency, unit of measure and display parameters, you can choose:

- Function: Vehicle speed, Angular velocity, Speed, Turbo RPM
- Sensor: Speed sensor or ABS speed
- Speed parameters in the proper bottom box

Please note: if you set one speed as ABS Speed the second will switch to ABS speed too as shown here below.

| ID | Name | Function | Sensor | Unit | Freq | Parameters |
|------|-------------|-------------|------------------|----------|-------|---------------------------|
| RPM | RPM | Engine RPM | RPM Sensor | rpm | 20 Hz | max: 16000 ; factor: 1 ; |
| Spd1 | Speed1 | Vehicle Spd | ABS speed sensor | km/h 0.1 | 20 Hz | wheel: 1600 ; pulses: 1 ; |
| Spd2 | Speed2 | Vehicle Spd | ABS speed sensor | km/h 0.1 | 20 Hz | wheel: 1600 ; pulses: 1 ; |
| Ch01 | Channel01 | Voltage | Generic 0-5 V | mV | 20 Hz | |
| Ch02 | Channel02 | Voltage | Generic 0-5 V | mV | 20 Hz | |
| Ch03 | Channel03 | | | | 20 Hz | |
| Ch04 | Channel04 | | | | 20 Hz | |
| Acc1 | InlineAcc | | | | 50 Hz | |
| Acc2 | LateralAcc | | | | 50 Hz | |
| Acc3 | VerticalAcc | | | | 50 Hz | |
| Gyr1 | RollRate | | | | 50 Hz | |
| Gyr2 | PitchRate | | | | 50 Hz | |
| Gyr3 | YawRate | | | | 50 Hz | |
| Accu | GPS Acc | | | | 10 Hz | |
| Spd | GPS Spd | | | | 10 Hz | |
| Alt | Altitude | | | | 10 Hz | |
| OdD | Odomete | | | | 1 Hz | |
| Luma | Luminosi | | | | 1 Hz | |

To set the four **Analog channels** click on the related row, a setting panel appears and you can choose function, sensor type, measure units, display precision or specific parameters.

6.2.2 – ECU Connection and configuration

MXm can be connected to your vehicle ECU. When possible documents explaining how to connect your MXm to your vehicle ECU are published on our website www.aim-sportline.com. As explained, MXm can communicate using all currently available communication lines: CAN, RS232, K-Line.

To load the ECU protocol in MXm configuration:

- enter “ECU Stream” tab
- press “Change ECU” button
- select ECU Manufacturer and ECU Model (in the example FORD/ MUSTANG 2010)
- press OK

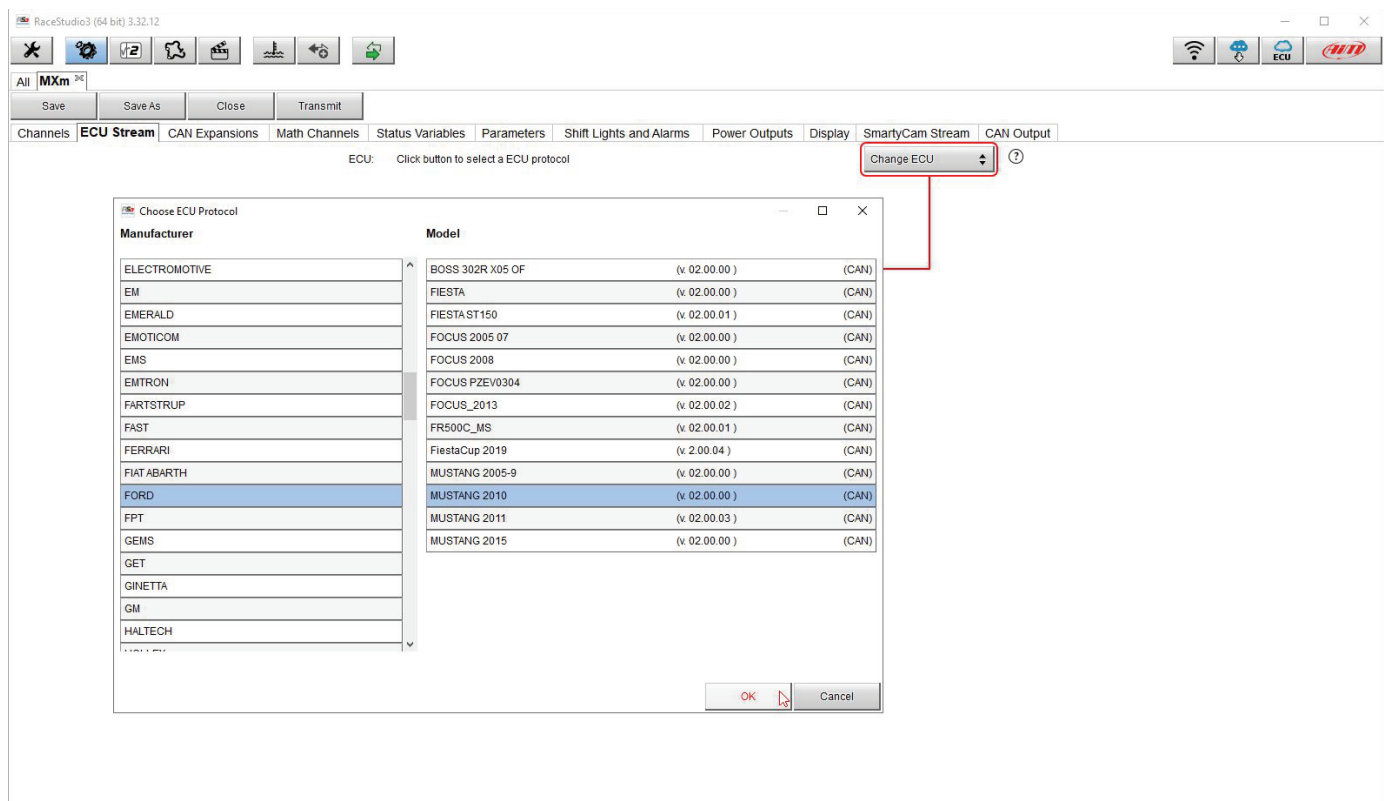

6.2.3 – LCU-One CAN setting

MXm can be connected to AiM LCU One CAN lambda controller plugging the 5 pins male Binder connector of LCU one in the female one of MXm 37 pins harness cable labelled “EXP” (see chapter 13 for further information).

Once the expansion connected you need to set it:

- enter “CAN Expansions” tab
- press “ADD Lcu-One CAN” button; it switches to “Remove LCU-One CAN”
- name your LCU One and fill in its serial number or press “Get Expansion Serial Number” to receive the serial number from the connected LCU-One
- select the multiplier to calculate AFR from lambda (in the example “14.57 Gasoline”) or add a custom value pressing “Add Custom Value” (the related panel shows up)
- set the LCU One channels double clicking on each channel and setting the panel that shows up.

The screenshot shows the RaceStudio3 interface with the 'CAN Expansions' tab selected. The 'LCC' expansion is configured with the name 'LCC' and serial number '0'. The multiplier for calculating AFR from lambda is set to '14.57 - Gasoline'. A red box highlights the 'Add Custom Value' button, which is linked to the 'Lambda Multiplier Manager' dialog box.

Expansion Settings:

- Expansion Name (6 characters max.): LCC
- Expansion Serial Number (S.N.): 0

Multipplier to calculate AFR (A/F) from lambda (AFR = Air Fuel Ratio = pounds of air / pound of fuel)

- Selected: 14.57 - Gasoline
- Available options: 6.40 - Methanol, 9.00 - Ethanol, 14.57 - Gasoline, 14.60 - Diesel, 15.50 - LPG (Propane), 17.20 - CNG

Channel List:

| ID | Name | Function | Sensor | Unit | Freq |
|-----|--|--------------|--------------------|-------------|-------|
| Lmd | <input checked="" type="checkbox"/> LCC Lambda | Lambda | AiM LCU-One Lambda | lambda 0.01 | 10 Hz |
| AFR | <input checked="" type="checkbox"/> LCC AFR | AFR | AiM LCU-One AFR | A/F 0.01 | 10 Hz |
| Ltm | <input checked="" type="checkbox"/> LCC LmdTmp | Lambda Temp | AiM LCU-One Temp | C 0.1 | 10 Hz |
| LDg | <input checked="" type="checkbox"/> LCC Diagn | Lambda Diagn | AiM LCU-One Diagn | # | 1 Hz |

Lambda Multiplier Manager Dialog:

| Multipplier Lambda Values | New Value | Label for New Value |
|---------------------------|-----------|---------------------|
| 6.40 - Methanol | 14.57 | Gasoline |
| 9.00 - Ethanol | | |
| 14.57 - Gasoline | | |
| 14.60 - Diesel | | |
| 15.50 - LPG (Propane) | | |
| 17.20 - CNG | | |

Buttons: Add or Modify Current Item, Remove Current Item, Restore Default Values, OK, Cancel.

6.2.4 – Math channels

Here you can create math channels; available options are:

- Bias: considering a relation between two mutually compatible channels it computes which one is prevailing (typically used for suspensions or brakes);
- Bias with threshold: it needs the user to set a threshold value for the considered channels; once these threshold values are both exceeded the system makes the calculation;
- Calculated gear: it calculates the gear position using engine RPM and vehicle speed
- Precalculated gear: it calculates the gear position using Load/Shaft ratio for each gear and for the vehicle axle too
- Linear correction: typically used when a channel is not available in the desired format or if it is wrongly tuned and cannot be tuned again
- Simple operation: it adds or subtract from a channel value another channel value or a constant value
- Blinkers hazard: calculates the blinking status of the turning signals and of the hazard

Each option asks the user to fill in a proper panel.

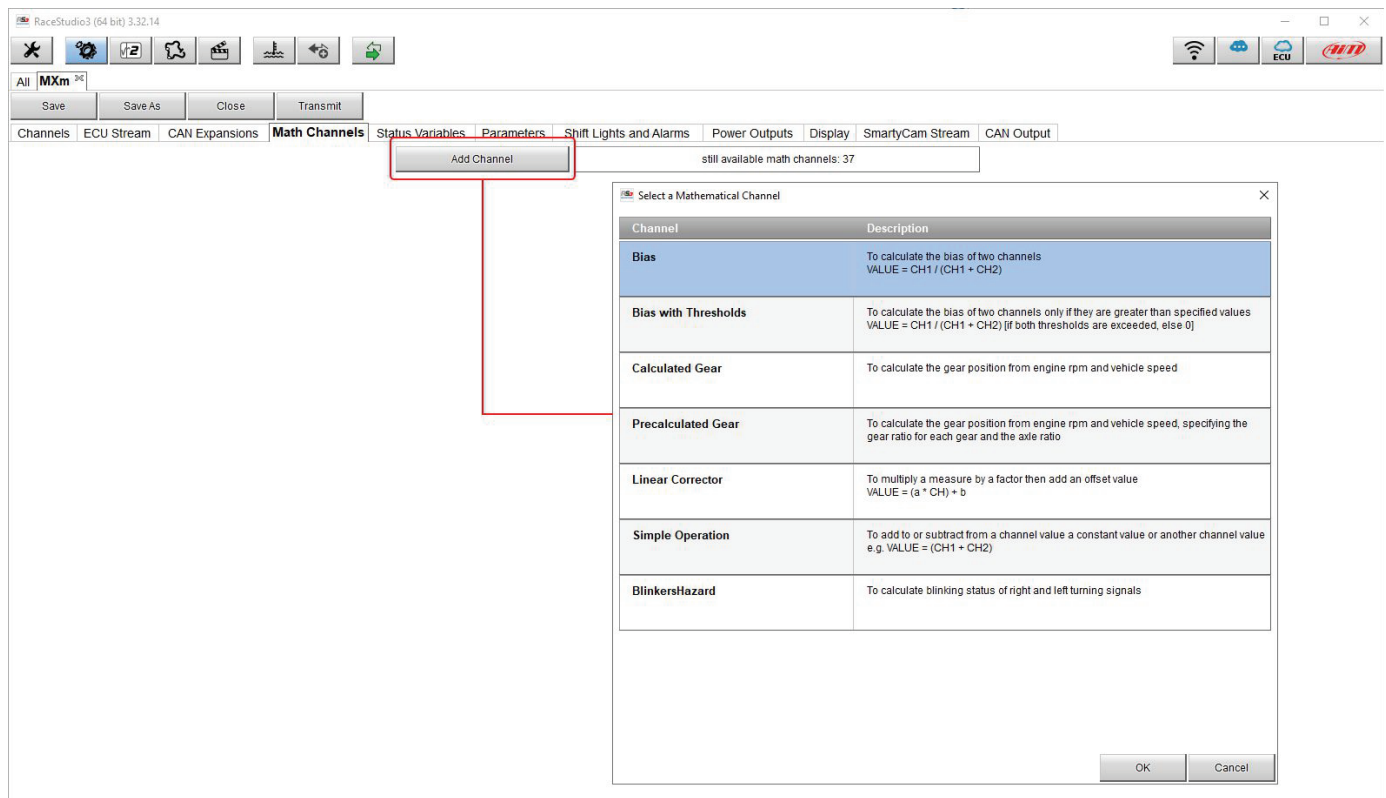

The screenshot shows the RaceStudio3 (64 bit) 3.32.14 interface. The 'Math Channels' tab is active, and the 'Add Channel' button is highlighted with a red box. A dialog box titled 'Select a Mathematical Channel' is open, displaying a table of available options:

| Channel | Description |
|----------------------|---|
| Bias | To calculate the bias of two channels VALUE = CH1 / (CH1 + CH2) |
| Bias with Thresholds | To calculate the bias of two channels only if they are greater than specified values VALUE = CH1 / (CH1 + CH2) (if both thresholds are exceeded, else 0) |
| Calculated Gear | To calculate the gear position from engine rpm and vehicle speed |
| Precalculated Gear | To calculate the gear position from engine rpm and vehicle speed, specifying the gear ratio for each gear and the axle ratio |
| Linear Corrector | To multiply a measure by a factor then add an offset value VALUE = (a * CH) + b |
| Simple Operation | To add to or subtract from a channel value a constant value or another channel value e.g. VALUE = (CH1 + CH2) |
| BlinkersHazard | To calculate blinking status of right and left turning signals |

The dialog box also includes 'OK' and 'Cancel' buttons at the bottom right.

6.2.5 – Status variables setting

Here you can set Status variables.

Status variables are user defined conditions that can be used in different situations. This means that when setting alarms in “Shift lights and Alarm” page you can set different alarms including the same condition (status variable) simply recalling it from the list. The status variable can also be logged checking “add to the device logged channels” checkbox thereby working as an analog channel. Pressing “Add New Variable” the related panel appears.

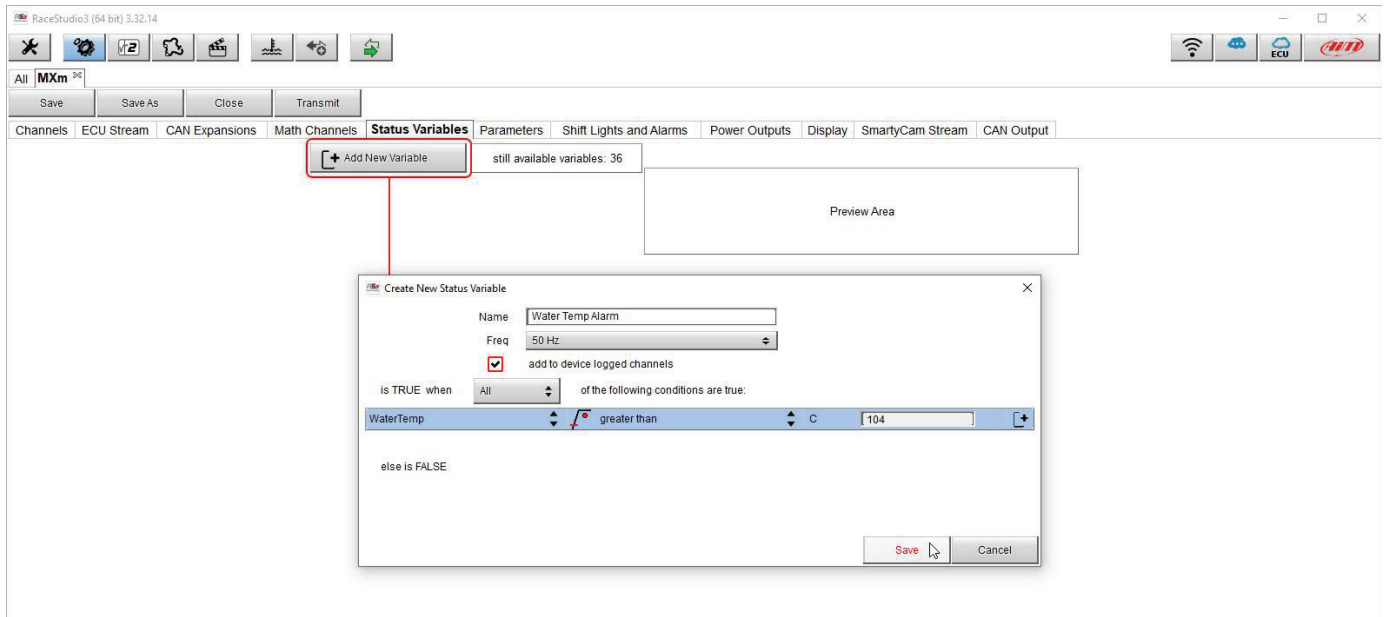

In the example below the user created a Status variable called “Water Temp Alarm”. Mousing over the status variable row a summary panel appears on the right while mousing over each square of the row a popo up explains its meaning.

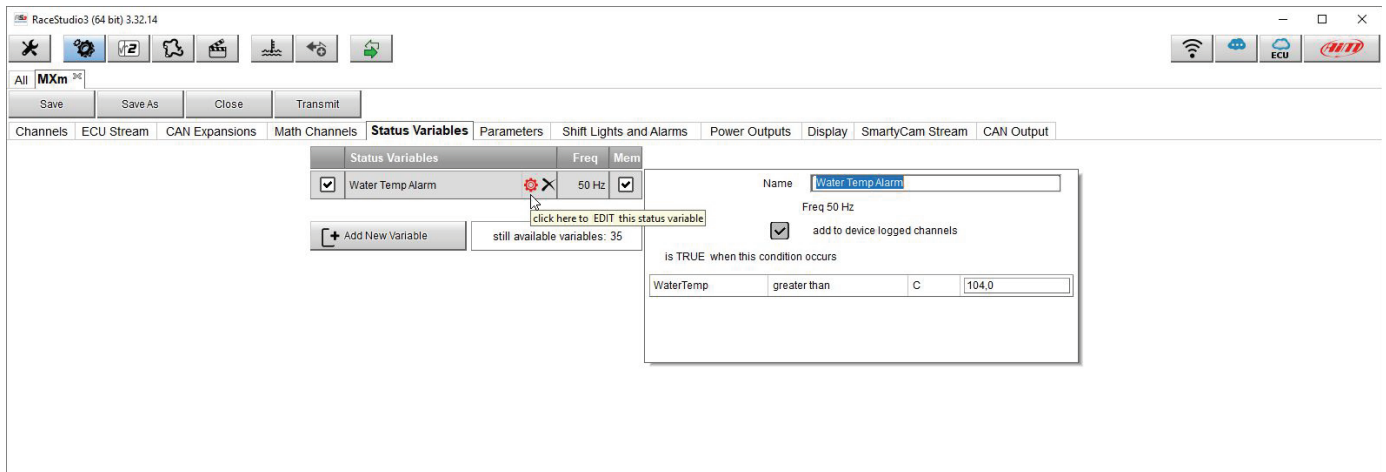

6.2.6 – Parameters settings

Parameters page is divided in three parts.

- on top **GPS Beacon** parameters; mousing over the question marks a pop up message explains the working mode of:
 - hold lap time for: the time period for which lap time is shown on MXm display
 - the track width: width that will be considered for any GPS point you set
- central **Reference speed**: here it is possible to decide which speed to use as reference one among these available; default setting is speed 1.
- bottom **Start data recording** conditions;
 - standard conditions (default setting) make MXm start recording when RPM is higher than 500 or speed is higher than 10 km/h and switches MXm Wi-Fi off
 - custom conditions: you can set two conditions and decide if making MXm start recording when only one of them is reached ("ANY") or when both are satisfied ("ALL"); click on the row corresponding to the custom condition and set it.

The screenshot shows the 'Parameters' tab in RaceStudio3. It is divided into three main sections:

- Lap Detection:**
 - Hold lap time for: 8 sec (with a callout: "This is the number of seconds that the lap time is held static on the display before resuming a dynamic views such as: predictive, current or running lap time")
 - GPS Beacon**:
 - Track Width: 10 m (with a callout: "This is the width that will be considered for any GPS points set(i.e. the width of the start/finish line)")
 - CAN Optical Beacon**:
 - Ignore additional lap signal for: 8 sec
- Reference Speed:**
 - Select the channel to use for reference speed**: Speed1 (dropdown menu)
- Start Data Recording:**
 - Standard Conditions**: Recording starts when RPM is greater than 500 or speed is greater than 10 km/h (if GPS is valid too)
 - Custom Conditions**:
 - Buttons: Any (highlighted), All
 - Table:

| Speed | Operator | Value | Unit |
|--------|--------------|-------|------|
| Speed1 | greater than | 10.0 | km/h |
| Speed2 | greater than | 10.0 | km/h |

6.2.7 – Shift Lights and Alarms

In this page you can set shift lights (on top) and set the alarm led (bottom) of your MXm.

The screenshot shows the RaceStudio3 (64 bit) 3.32.14 interface. The 'Shift Lights and Alarms' tab is active. At the top, there are two radio buttons: 'Use for predictive time' (unselected) and 'Use as gear shift lights' (selected). Below this is a table for configuring shift lights:

| Gear | Shift Light 1 | 2 | 3 | 4 | 5 |
|------|---------------|------|------|------|-------|
| All | 9200 | 9400 | 9600 | 9800 | 10000 |

Each cell in the table contains a small colored light icon. Below the table is an 'Activate Simulation' checkbox. In the center, there is a virtual image of the MXm dashboard with five colored shift lights (1-5) illuminated. At the bottom, there is a control bar with a '+ Add New Alarm' button, a text field showing 'still available alarms: 35', and 'Import Alarm' and 'Export Alarm' buttons.

On top you can set your MXm shift lights working mode. Available options are shift lights (default) and predictive time.

Use as gear Shift Lights To use the led bar as shift lights click the setting icon (⚙️) and the related panel shows up. You can

- import/export shift lights setting using the proper buttons
- decide the sequence mode of the LEDs enabling the desired option:
 - a LED stays on if its threshold is exceeded
 - a LED stays on until another LED with higher threshold turns on or
- link the shift lights to the engaged gear enabling the related checkbox; in this last case you need to fill in max gear number and set LEDs colours and threshold values for each gear.

Shift Lights Options

Choose a sequence mode of shift lights

ALED stays on if its threshold is exceeded

ALED stays on until another LED with higher threshold is turned on

Choose the engine rpm channel: RPM

Gear dependent shift lights Max gear number: 6

Choose the gear channel: Gear

Select colors and threshold values for shift lights:

| Gear | Shift Light 1 | 2 | 3 | 4 | 5 | |
|------|---------------|------|------|------|-------|--|
| 6 | 9200 | 9400 | 9600 | 9800 | 10000 | |
| 5 | 9200 | 9400 | 9600 | 9800 | 10000 | |
| 4 | 9200 | 9400 | 9600 | 9800 | 10000 | |
| 3 | 9200 | 9400 | 9600 | 9800 | 10000 | |
| 2 | 9200 | 9400 | 9600 | 9800 | 10000 | |
| 1 | 9200 | 9400 | 9600 | 9800 | 10000 | |

Use for predictive time. To use the LED bar for predictive lap time enable the related option and press the setting icon (⚙️).

You can

- import/export shift lights setting using the proper buttons
- decide the sequence mode of the LEDs enabling the desired option:
 - a LED stays on if its threshold is exceeded
 - a LED stays on until another LED with higher threshold turns on or
- fill in the predictive time increment of each LED. The LED value indicates the time gap to be assigned to each LED. Assuming you fill in "0.1" and your lap time is improving of 0.3 sec toward the reference lap, your MXm will switch on 3 LEDs green; if, on the contrary, your lap time is worsening the LEDs will switch on red. The lap considered as reference is the best one of the current session.

Channels | ECU Stream | CAN Expansions | Math Channels | Status Variables | Parameters | **Shift Lights and Alarms** | Power Outputs | Display | SmartyCam Stream | CAN Output

Use for predictive time Use as gear shift lights

| Channel for LED-bars | Incremental Time per LED |
|----------------------|--------------------------|
| + Best Time | 0.10 sec |

Activate Simulation

Predictive Time Bar Options

Choose a sequence mode of shift lights

ALED stays on if its threshold is exceeded

ALED stays on until another LED with higher threshold is turned on

Predictive Time Increment per LED: (sec)

OK Cancel

+ Add New Alarm still available alarms: 35 Import Alarm Export Alarm

Create and set MXm alarm

As for any AiM logger you can import/export alarms using the related buttons but you can also create new ones. To create a new alarm press “+ Add new Alarm”

The screenshot shows the RaceStudio3 (64 bit) 3.32.14 interface. The 'Shift Lights and Alarms' tab is active, displaying a table for configuring gear shift lights and a preview of the MXm dashboard. A 'Create New Alarm' dialog box is open, showing the configuration for a new alarm.

| Gear | Shift Light 1 | 2 | 3 | 4 | 5 |
|------|---------------|------|------|------|-------|
| 1 | 9200 | 9400 | 9600 | 9800 | 10000 |

Activate Simulation:

Buttons: + Add New Alarm, still available alarms: 35, Import Alarm, Export Alarm

Create New Alarm Dialog:

- Description: [Empty field]
- If: All of the following conditions are true:
- Condition: Speed1 less than 0.0 km/h
- Action: Popup Message timed [insert message text] until alarm end
- Until: condition no longer met
- Buttons: Save, Cancel

To set the new alarm:

- fill in description box on top of "Create New Alarm Panel" (1)
- if more conditions are to be set decide whether all conditions are to be satisfied or just one (Any/All button "2")
- click "Channel" cell
- "Select Channel" panel shows up on the right ("3")
- as you can see in the image below if you set a status variable (Water Temp Alarm in the example) you find it in the available channels list: select the channel you prefer and press "OK"
- decide which actions to set among ("4"):
 - Pop up a colour message timed
 - Switch a LED on: decide colour and blinking frequency
- decide until when keeping on the alarm "5" ("Until") among:
 - condition no longer met
 - the device is turned off
 - a button is pushed
 - data are downloaded
- "+" buttons right of the panel are to add new alarms ("6") or to add new actions to an alarm ("7")
- When more conditions are set "-" buttons appears left of "+" button: press it to delete a condition or an action
- when all operations have been performed press "Save" ("8").

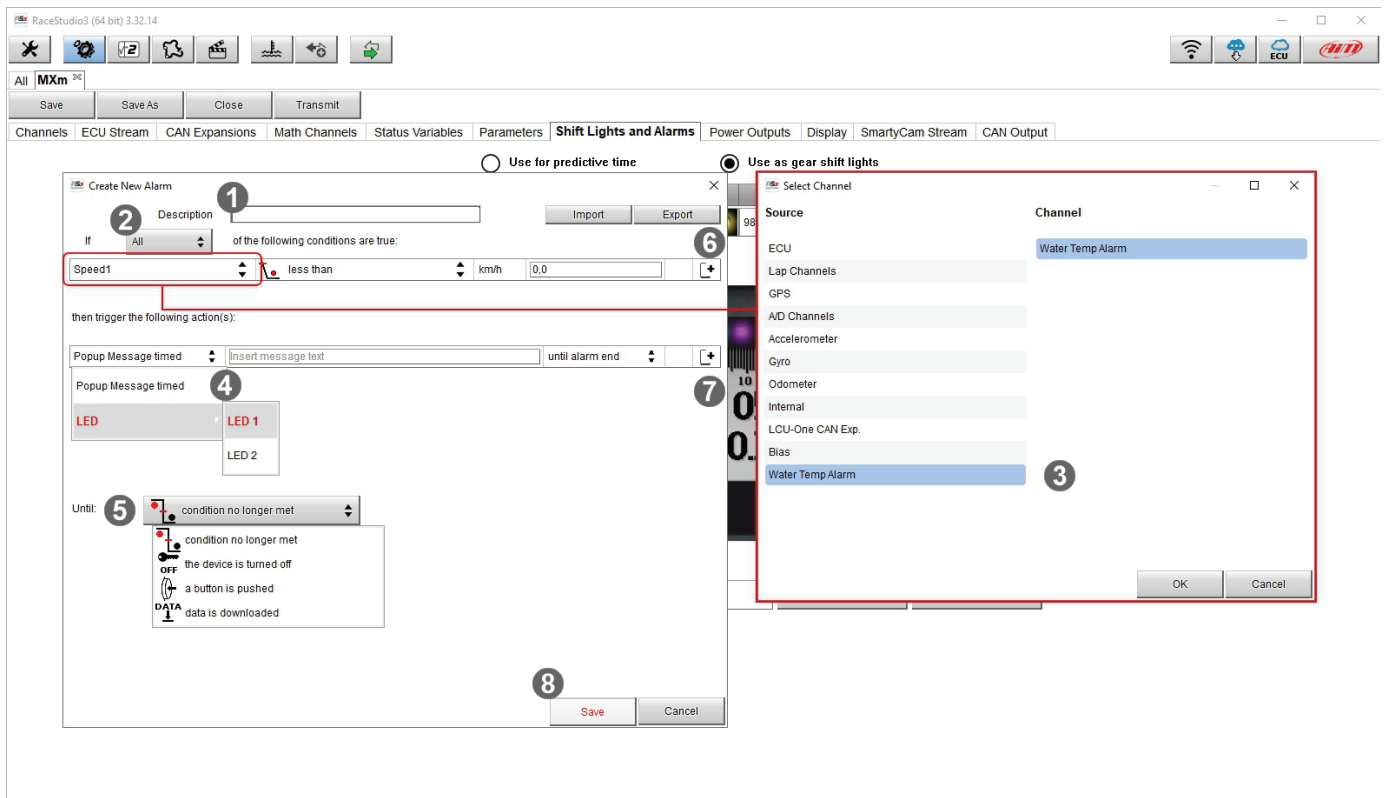



Bottom of the page an Alarm summary is shown. Right clicking on the setting icon, you can edit and modify or delete the alarm. Editing the alarm its "Modify Alarm" panel shows up.

Use for predictive time Use as gear shift lights

| Channel for LED-bars | Incremental Time per LED |
|----------------------|--------------------------|
| + Best Time | 0.10 sec |

Activate Simulation

| priority | Events | Alarms | Output | Message |
|-------------------------------------|----------------|--------|--------|-----------------------------|
| <input checked="" type="checkbox"/> | Water Temp | LED: 1 | Output | |
| <input checked="" type="checkbox"/> | Stop Recording | LED: | Output | Popup Message: Recording of |

+ Add New Alarm still available alarms: 33 Import Alarm Export Alarm

Edit Selected Alarm
Delete Selected Alarm

6.2.8 – Power Outputs setting

MXm features 2 Power outputs, that can drain up to 15 Amp each. The power output connector, highlighted here below, is a four pin connector.

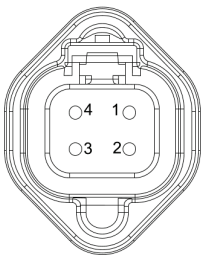
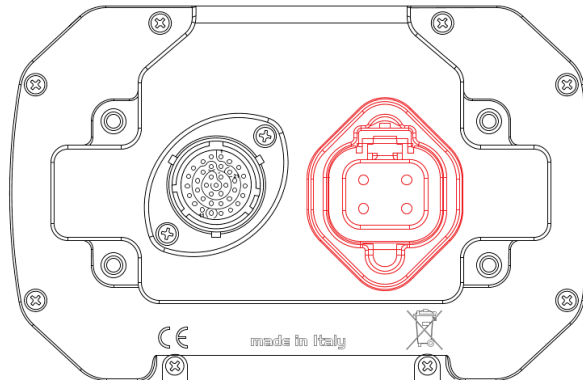

| Pin | Function |
|-----|-------------------|
| 1 | High side output2 |
| 2 | 9-15V power input |
| 3 | 9-15V power input |
| 4 | High side Output1 |

Each Power output is managed by three channels:

- the output (ON or OFF)
- the drained current
- the Status (OK, Shortcut, Overcurrent, Open Circuit)

To set the two power outputs:

- enter Power output page
- mouse over the power output you want to set
- setting icon appears on the right of the power output row: click it

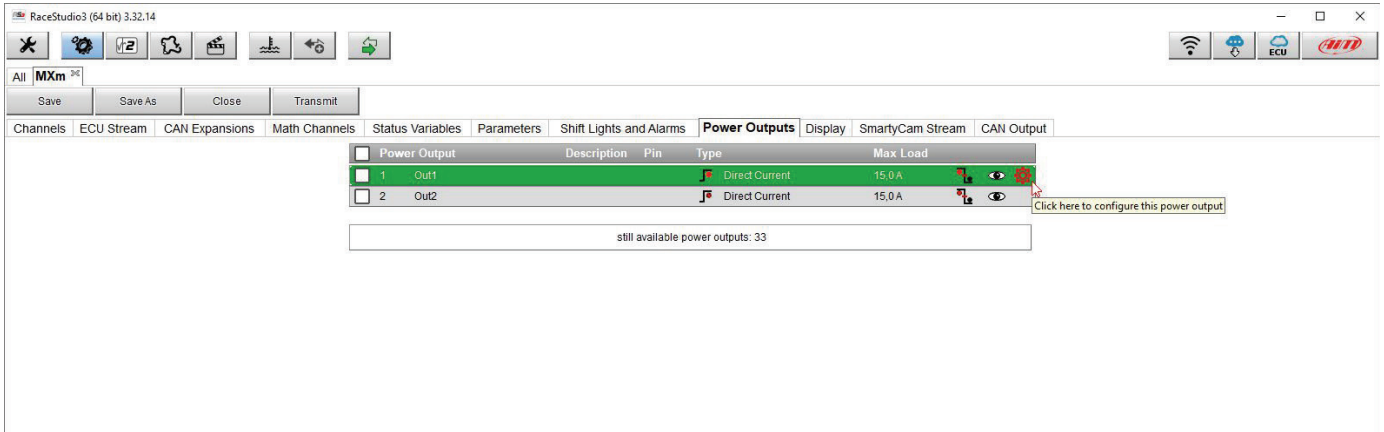

The setting panel appears: fill it in. In the example Power output 1 has been configured to manage a fan: it turns ON when Water temperature is greater than 90°C: Max accepted current (Maximum value of requested Loan) is 8 Amp: over this value the output circuit opens and the read status becomes "Overcurrent".

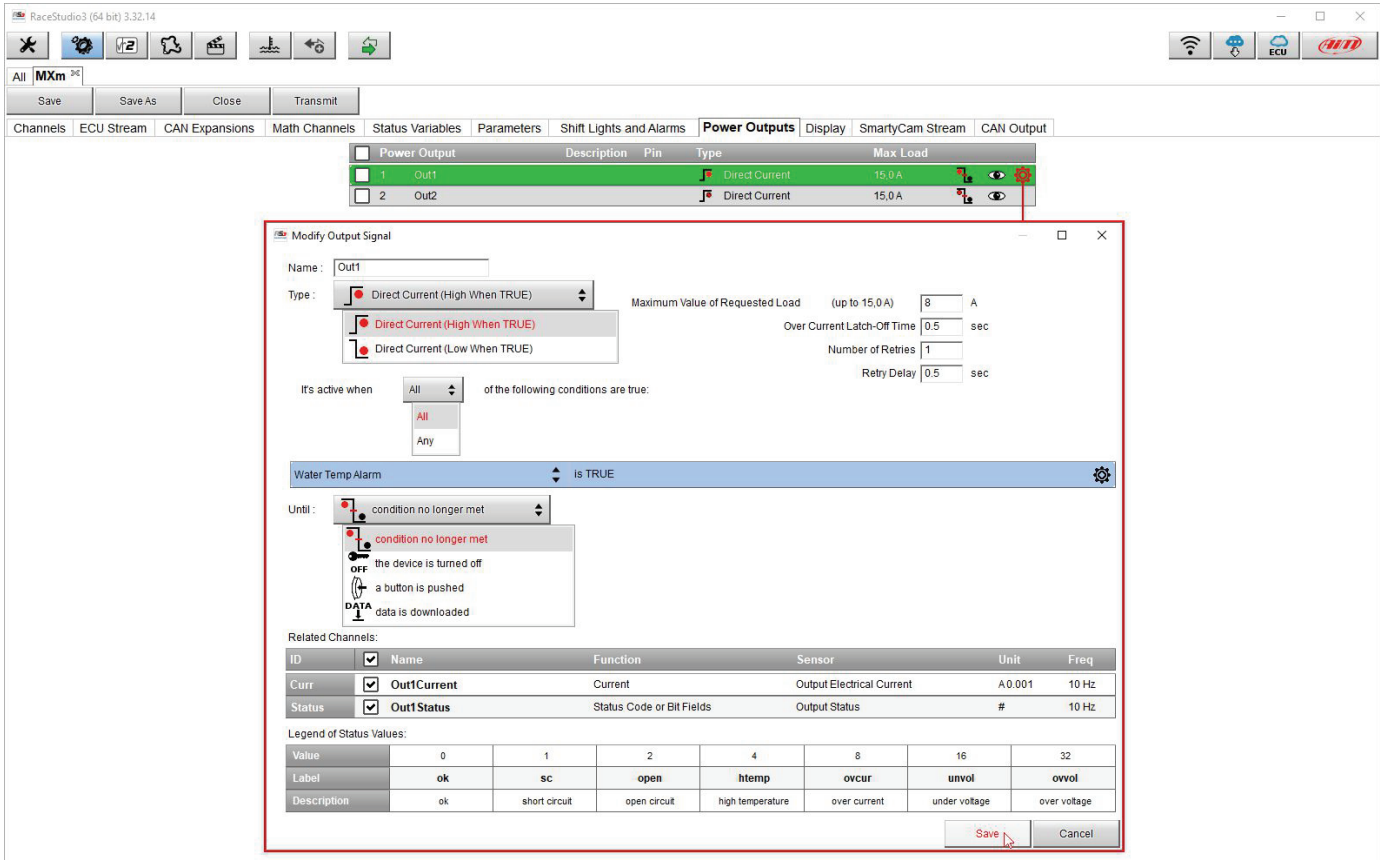

6.2.9 – Display settings

MXm can have up to eight pages to be set via software. Each page can have from 1 to 4 fields and can be set as you prefer.

- enter “Display” tab
- a panel shows up where you can select the display page you prefer (in the example a four fields page with bar graph has been chosen)
- select the page and press “OK”
- repeat the operation for the number of pages you want to set

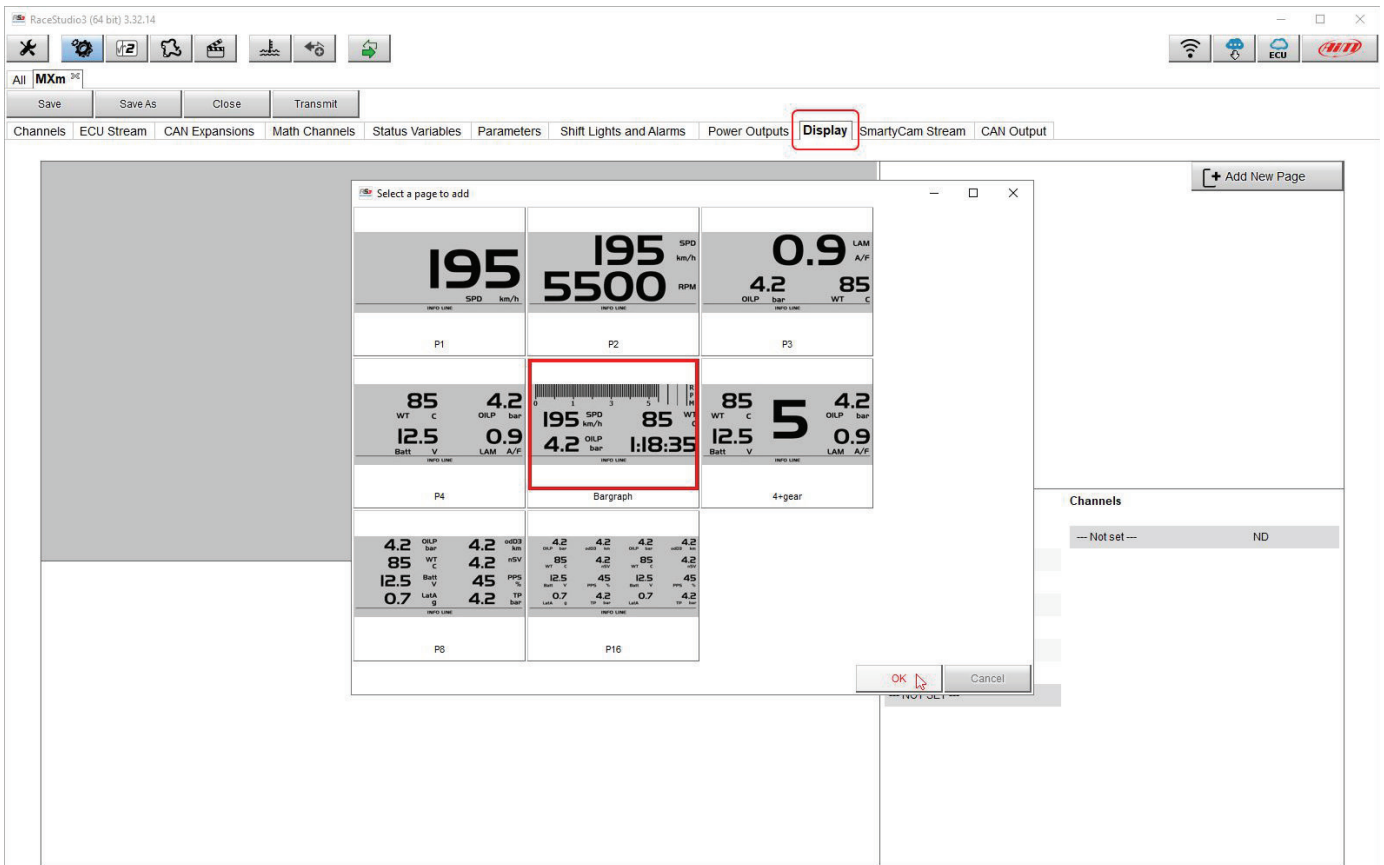

When the page has been selected two setting panels appears bottom of the page:

- on the left a panel that shows as many rows as the fields to be set (in the example 5 fields)
- on the right a panel shows the channels group you can set in that field and all the channels in it included; you can drag and drop the channel you want to set in the desired field or double click on it
- if you added more display pages the one you are setting is indicated top of the tab as highlighted here below; repeat the operation for all the pages loaded in the configuration.lw

The screenshot shows the RaceStudio3 interface with the 'Display' tab selected. The main display area for 'Page 1' shows the following data:

- RPM: 0 to 14 (with a vertical line at 12)
- ECT: 0.1 C
- Spd: 0.1 km/h
- Gear: 5
- LapT: 1:18:35

Below the main display is an 'INFO LINE' and a settings table:

| Field | Channel | Unit | Value |
|-----------|---------|------|-------|
| RPM | RPM | rpm | 16000 |
| WaterTemp | ECT | C | |
| SpeedVeh | Spd | km/h | |
| Gear | Gear | gear | |
| Lap Time | LapT | | |

On the right, the 'Channel Groups' and 'Channels' list shows the following available channels:

- ECU: RPM, RPM
- Lap Channels: SpeedVeh, Spd
- GPS: SpeedFL, SpFL
- A/D Channels: SpeedFR, SpFR
- Accelerometer: SpeedRL, SpRL
- Gyro: SpeedRR, SpRR
- Odometer: Gear, Gear
- Internal: WaterTemp, ECT
- LCU-One CAN Exp.: TurboBoost, TurB
- Math Channels: TCSBrakeEvent, TCSB
- Status Variables: TCSEngEvent, TCSE
- Power Outputs: StabCtrlTetal, SCTE
- NOT SET ---: StabCtrlMXTX, SCMT
- TyreR, Mile: TyreR, TjRM
- FuelLevelMean: Fuel

6.2.10 – SmartyCam stream setting

MXm can be connected to AiM SmartyCam to show the data you wish on SmartyCam video. To set each channel:

- click on it and a setting panel shows up
- it shows all channels and/or sensors that fits the selected function
- in case you do not find the channel or the sensor in the list enable “Enable all channels for functions” checkbox and all channels/sensors will be shown
- once all channels set your configuration is finished: press “Transmit” on the page top keyboard.

Enable all channels for functions

| SmartyCam Function | Channel |
|--------------------|-----------------|
| Engine RPM | RPM |
| Speed | GPS Speed |
| Gear | Gear |
| Water Temp | WaterTemp |
| Head Temp | -- Not Set -- |
| Exhaust Temp | -- Not Set -- |
| Oil Temp | -- Not Set -- |
| Oil Press | -- Not Set -- |
| Brake Press | FrontBrake Pres |
| Throttle Pos | -- Not Set -- |
| Brake Pos | -- Not Set -- |
| Clutch Pos | -- Not Set -- |
| Steering Pos | SWAngle |
| Lambda | LCC Lambda |
| Fuel Level | -- Not Set -- |
| Battery Voltage | Battery |

Select Channel

| Source | Channel |
|------------------|---------------|
| ECU | TyreRMile |
| Lap Channels | FuelLevelMean |
| GPS | FuelInst1 |
| A/D Channels | FuelInst2 |
| Accelerometer | AxleRatio |
| Gyro | PedalPosition |
| Odometer | YawRate |
| Internal | LateralAcc |
| LCU-One CAN Exp. | SWAngle |
| Math Channels | TrAct |

OK Cancel

6.3 – Managing a track on MXm with Race Studio 3

With Track Manager function of Race Studio 3 you can create, delete and modify tracks, transmit and receive them to/from your MXm. Press “Tracks” icon.

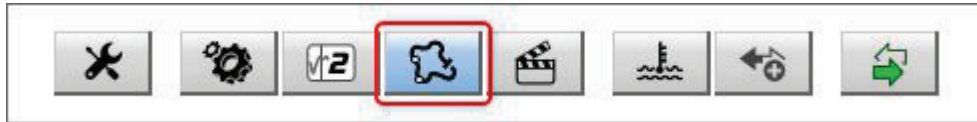

The main page is divided in three columns; on the **left**:

- on top, the filters that allow to collect many tracks following customized criteria; by default, all tracks are shown (light blue “All Tracks” filter in the image below).
- bottom left, the connected devices (in the image, “MXm ID 6500100”)

The column **in the middle** shows:

- on top a fast search bar, that allows to select the tracks which satisfy your personal research criteria; by pressing “?” a pop-up window explains research criteria (highlighted in red below), where:
 - long name is the name you see in bold in each track box
 - short name is the track name shown on the display of MXm and is the name you find top right of each track box
 - track city is the name of the city the track is located in
- all the tracks listed in Race Studio 3 database. It automatically updates when a connection to the Internet is available.

The column on the **Right** shows:

- the data sheet of the track you are mousing over.

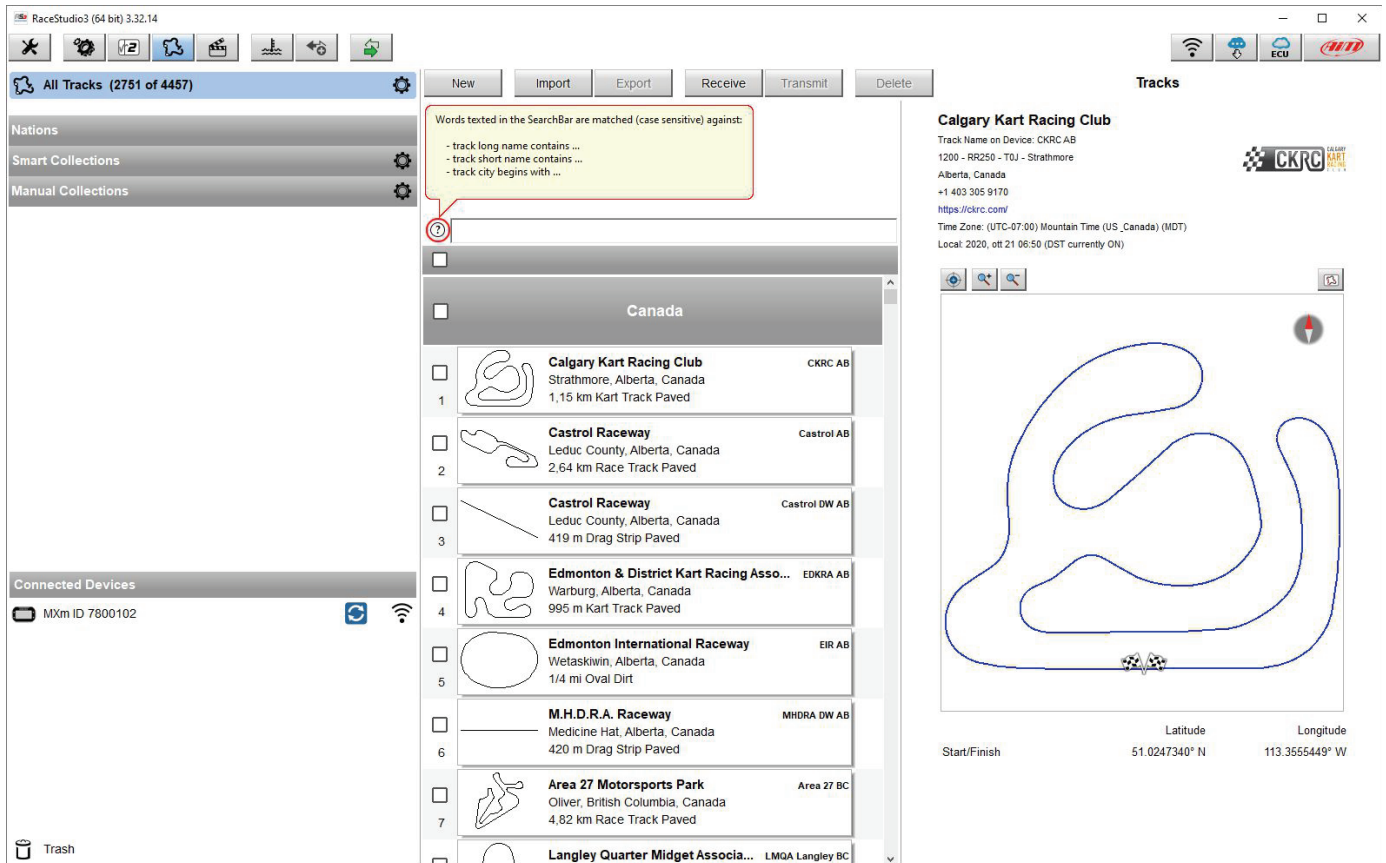

When your MXm is connected it is shown on the left bottom part of the page as said before. Clicking on it all the tracks it contains are shown in the right column of the page. The tracks you created are labelled “user” in red.

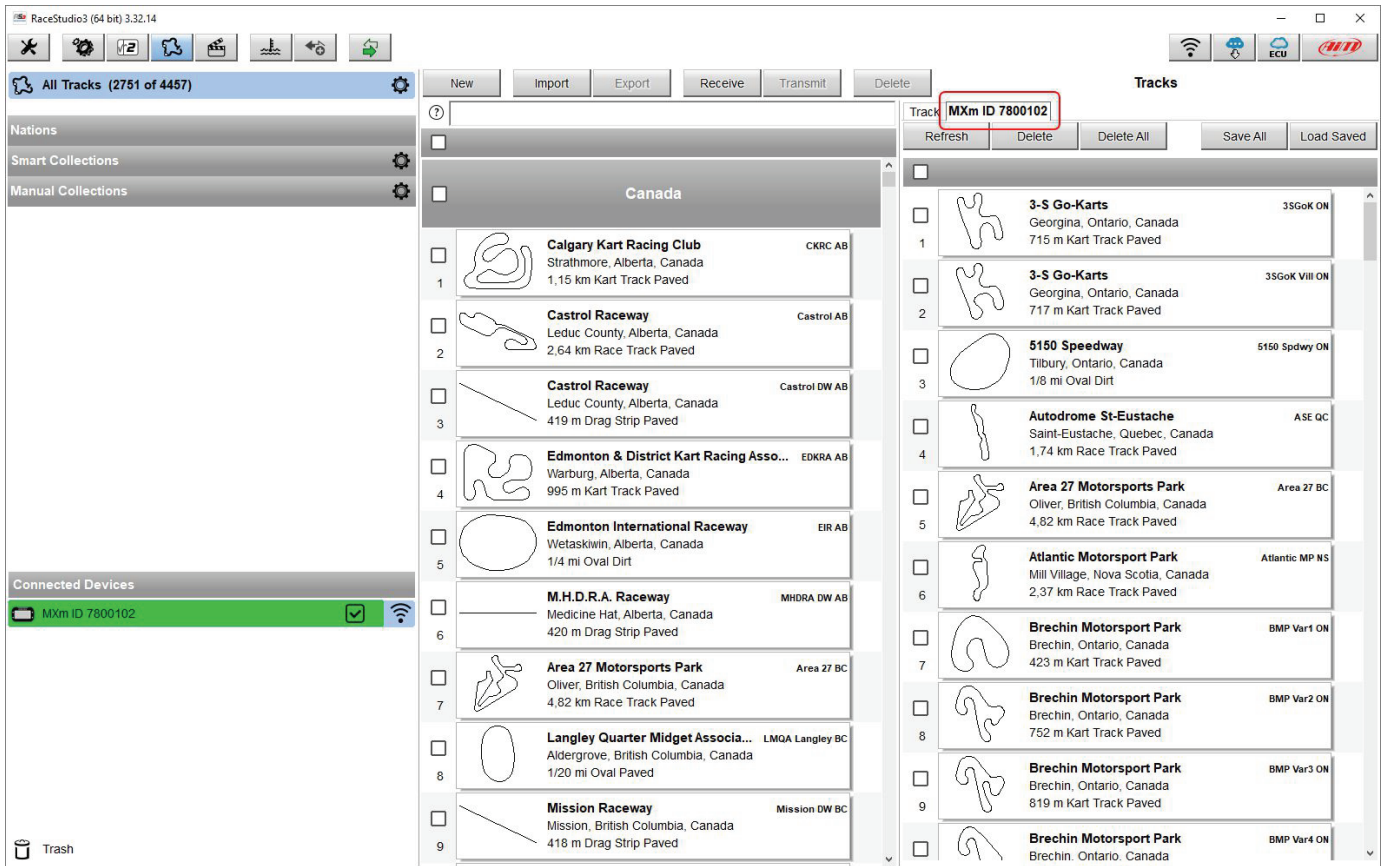

The page keyboards are used to manage the tracks. The keyboard you find above the central column allows you to:

- **New:** create a new “custom” track; to create a custom track (see also paragraph 5.5):
 - Press “New” and fill in new track panel (you can also insert only start/finish line coordinates) or
 - Edit an existing track as explained in the following page
 - Press “Save”
- **Import/Export:** import/export one or more tracks you stored in/to your MXm or another peripheral device
- **Receive:** receive from your connected MXm the tracks you created (if no device is connected the button is disabled)
- **Transmit:** transmit one or more tracks from the PC to your connected MXm (if no device is connected the button is disabled)
- **Delete:** delete one or more tracks from Race Studio 3 Database

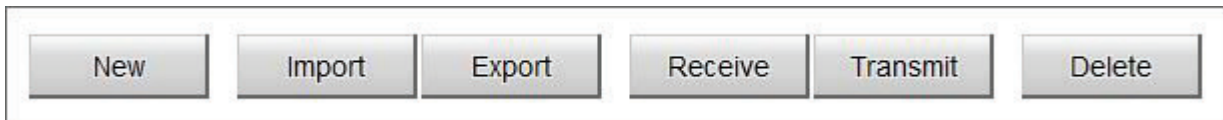



The keyboard you find above the right column allows you to:

- **Refresh:** refresh the track list stored in your connected MXm
- **Delete/Delete All:** delete one or more/all tracks from your MXm memory
- **Save all:** save all the tracks stored in your connected MXm; it creates a zip file you can load to another AiM device
- **Load Saved:** load the tracks you previously saved in your connected MXm memory



To create a custom track from an existing one:

- select the track map and press the setting icon of the column
- select "Open Selected Track(s) for Editing" option.

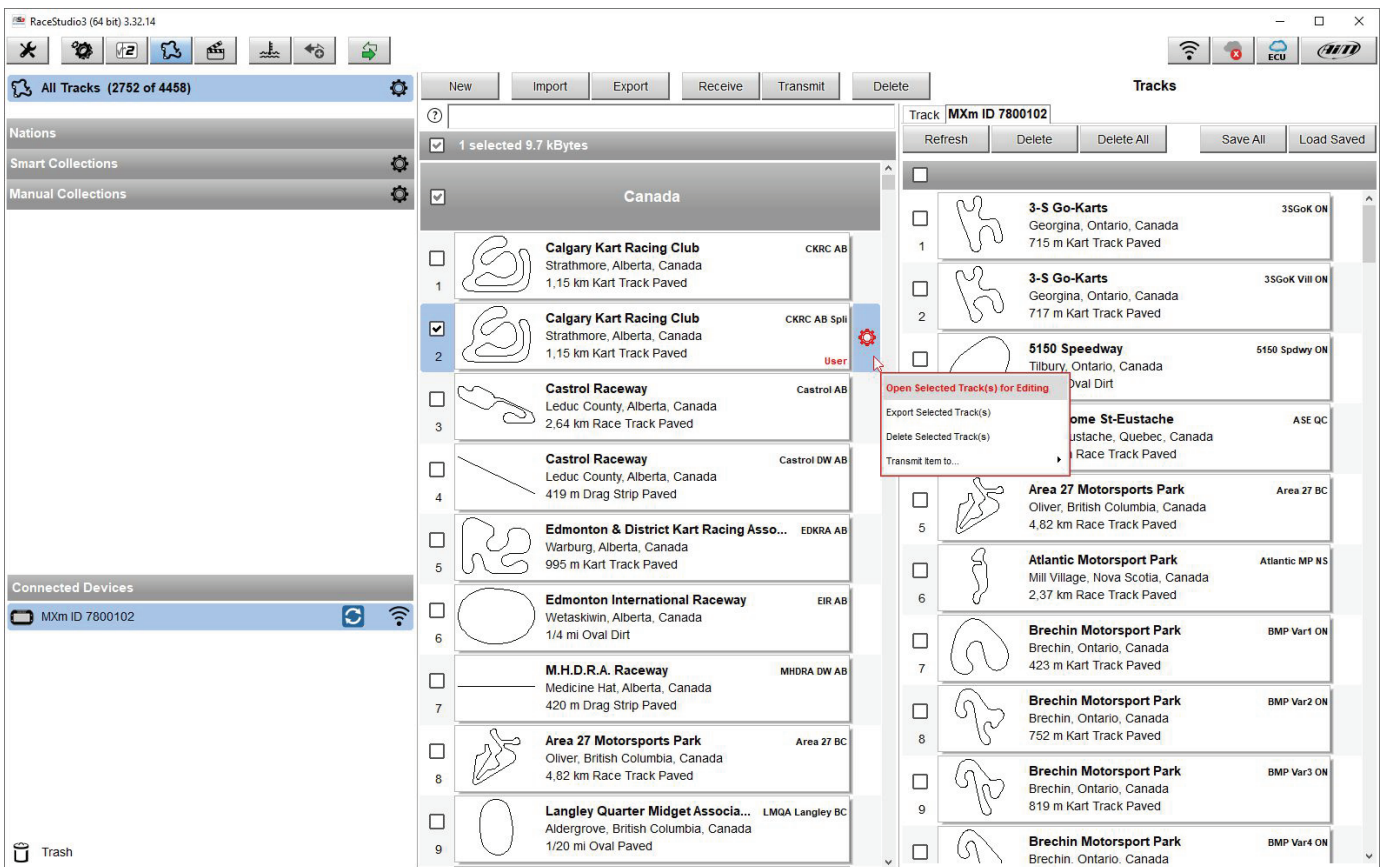

A page for modifying the track information appears. It may be useful to know that:

- "Track name short" is the name you will see on your device
- "Circuit type" and "Road surface", even if not necessary to set the track, are used by the research filters.

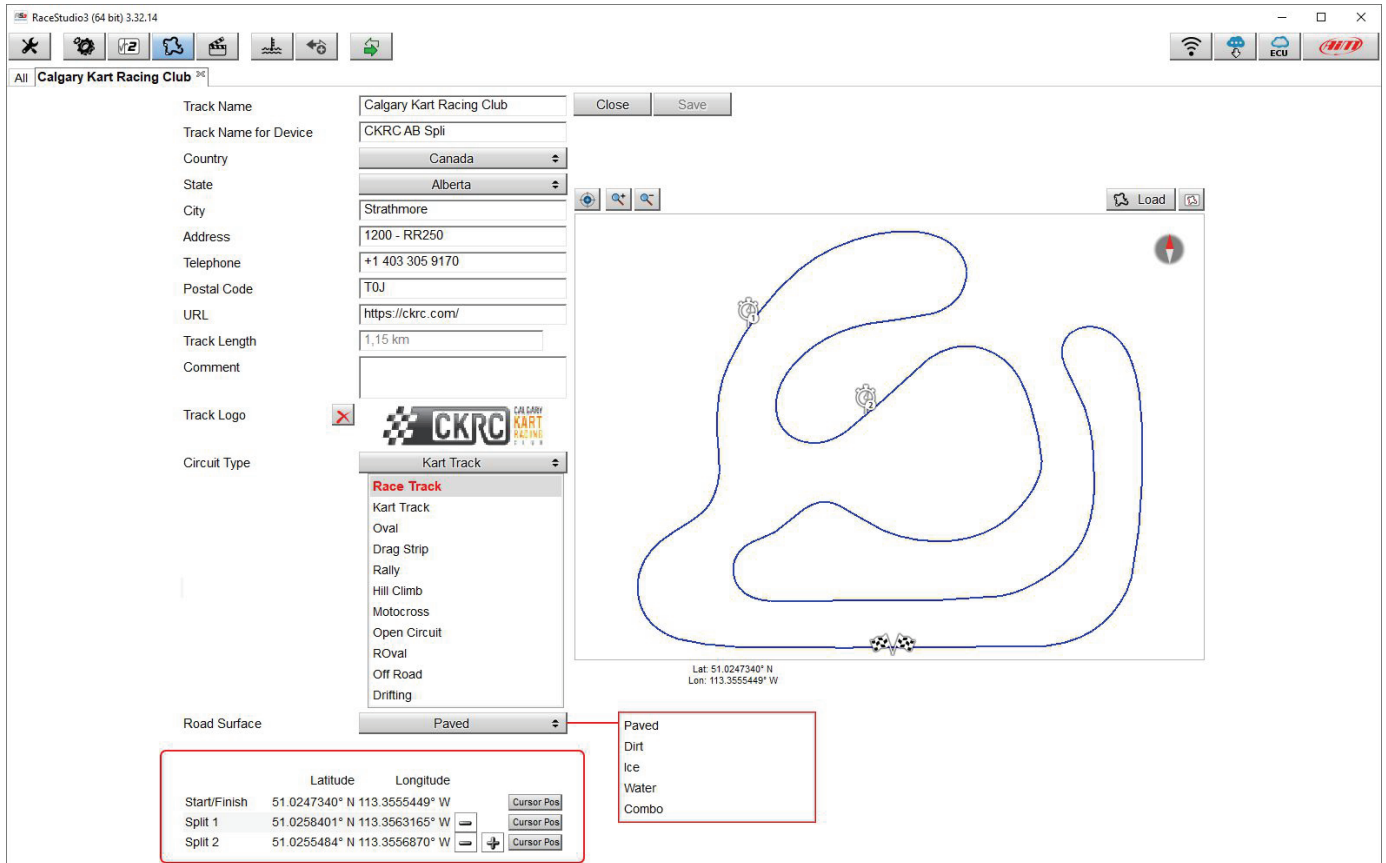

It is possible to change the start line position (move the cursor and set "Cursor Position") and to add split points in order to organize the track in different segments. This will be used in Data Analysis.

Press "Save" and the new track will appear in the list labelled "User".

Since the software is constantly updated, may be other information or features will be available soon. Please check our website www.aim-sportline.com documentation area software section "Track Manager" manual.

6.4 – ECU Driver builder



If your vehicle ECU is not included in Race Studio 3 software you can use CAN Driver builder to create your own CAN protocol. Press CAN Protocols button shown here above and then "New". The panel shown below appears. You can add a new ECU Manufacturer and/or a new ECU model.

Please note: this Race Studio 3 function is for expert users only and a CAN Driver builder user manual can be freely downloaded from AiM website at www.aim-sportline.com, documentation area software/firmware section.

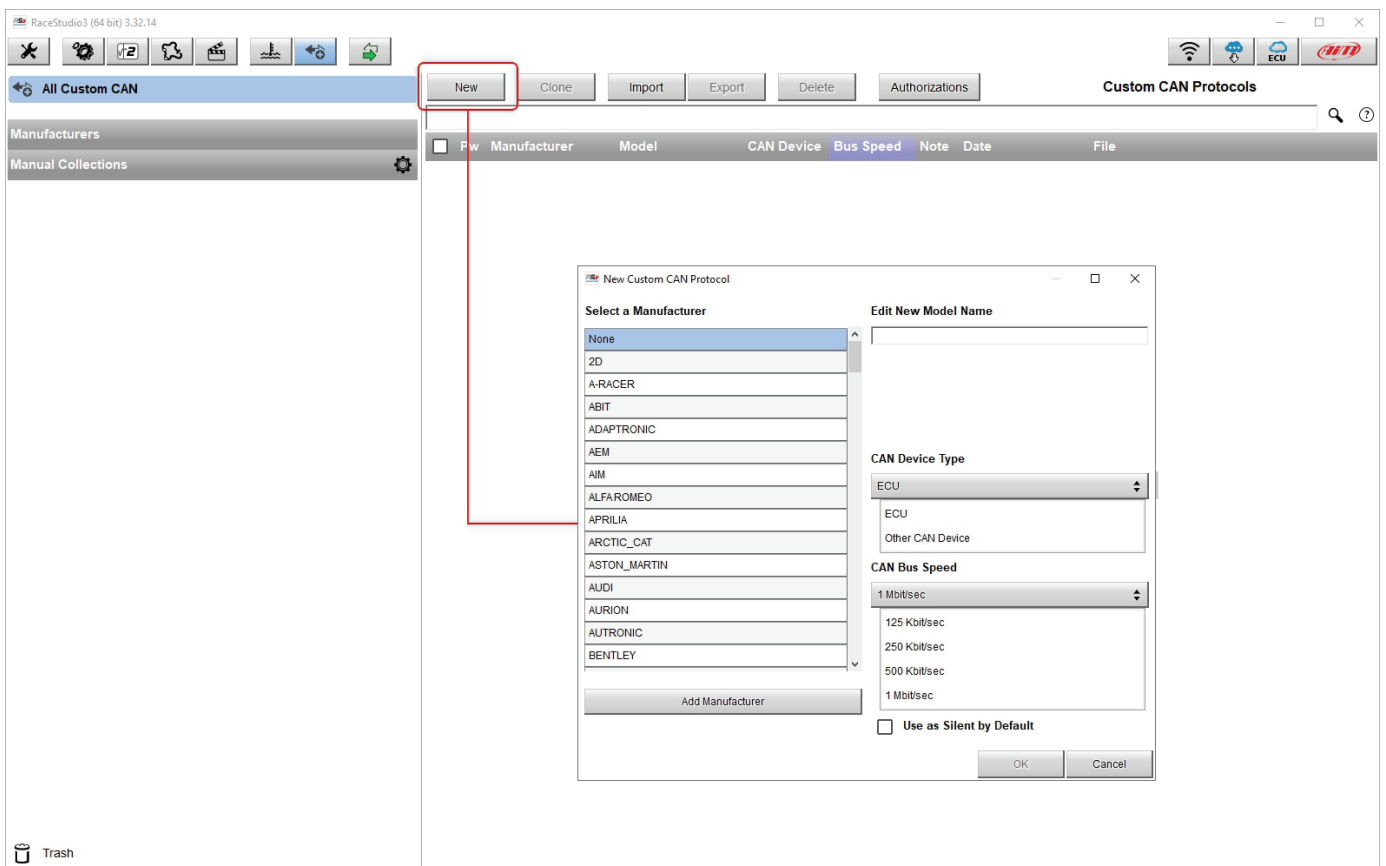

6.5 – The device window

The screenshot shows the RaceStudio3 software interface. The main window is titled "MXm ID 7800102" and is divided into several sections. On the left, there is a sidebar with "All Configurations", "Devices (2)", "Manual Collections", and "Connected Devices". The "Connected Devices" section shows "MXm ID 7800102" with a refresh and Wi-Fi icon. The main area is titled "Live Measures" and contains a table of sensor data. The table is organized into several sections: "Master", "GPS channels", "Lap channels", and "LCU-One CAN - Serial 1009857".

| Master | | | |
|------------------------------|-----------------|--------------------|-----------|
| InlineAcc | -0.78 g | RPM | 0 rpm |
| LateralAcc | 0.52 g | Speed1 | 0.0 km/h |
| VerticalAcc | 0.28 g | Speed2 | 0.0 km/h |
| RollRate | -1.5 deg/s | Logger Temperature | 36.5 C |
| PitchRate | -3.5 deg/s | Channel01 | 4 mV |
| YawRate | -0.1 deg/s | Channel02 | 7 mV |
| Channel03 | 8 mV | Channel04 | 8 mV |
| External Voltage | 4.2 V | Luminosity | 19 % |
| GPS channels | | | |
| GPS - Altitude | 167.09 m | GPS - Pos Accuracy | 5.51 m |
| GPS - Latitude | 45.537804 N deg | GPS - Sat Number | 11 |
| GPS - Longitude | 9.335344 E deg | GPS - Spd Accuracy | 43.0 km/h |
| GPS - Speed | 1.0 km/h | iGPS | GPS Good |
| Lap channels | | | |
| Lap - Lap Number | 0 | Lap - Split Number | 0 |
| Lap - Run Number | 0 | Lap - Split Time | 0.00.000 |
| Lap Time | 0.00.000 | | |
| LCU-One CAN - Serial 1009857 | | | |
| LCC Diagn | # | LCC Lambda | lambda |
| LCC LmdTmp | C | LCC AFR | A/F |

Clicking MXm bottom left of the software page you enter in device page, made up of 8 layers.

The first one is "Live Measures" (highlighted in red in the image above). Top of the layer are six buttons that allow to:

- Start/stop live measure stream from MXm (1)
- Show channels as managed by the firmware (Sort by configuration), in alphabetical order or by channel type (2)
- Calibrate/auto-calibrate channels that need it (3)
- Show values in millivolt too (4)
- Start/stop data recording (5)
- Make MXm LEDs blink (6); this is the quickest and easiest way to test PC-device connection

Download layer is to download sampled data, see the related chapter

Wi-Fi and Properties layer is to manage Wi-Fi configuration – see the related paragraph.

Settings layer allows to:

- Set date format
- enable/disable daylight saving time
- set time format and zone
- set the backlight
- enable/disable night vision

The arrows left of the buttons are to scroll the option while the right ones open the menus.

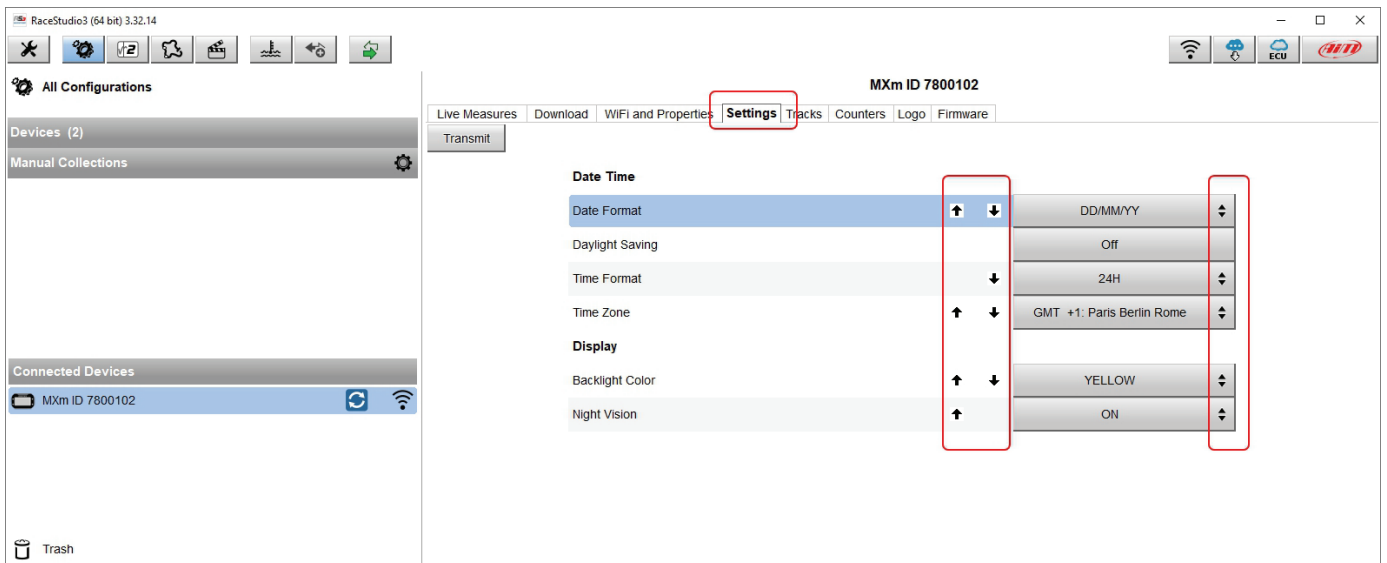

Tracks layer manages the tracks stored MXm memory.

Counters layer allows to set/reset each odometer except system one that is not editable. Setting icon top of counters table allows to switch from decimal to Imperial measure units as well as to decide the number of decimal places to show on the display

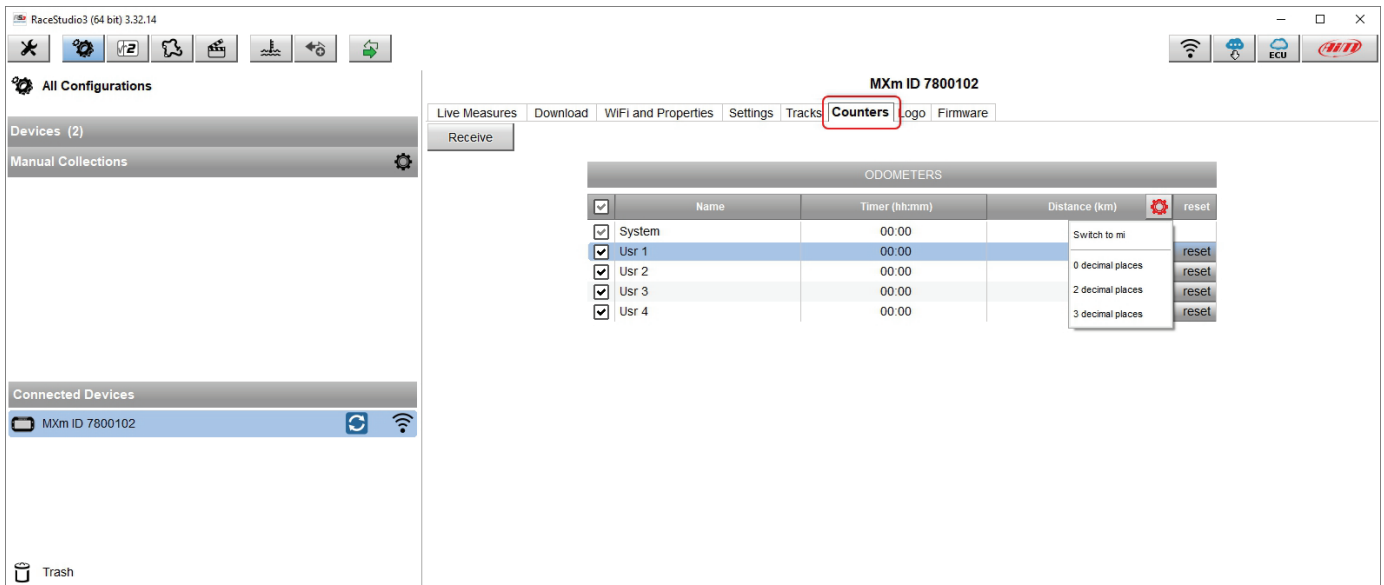

Logo layer allows to transmit/receive the logo that shows up when switching MXm on; supported image format are JPEG or BMP; always use the most recent Windows™ versions (Windows8 or Windows10) whose graphic libraries are more updated.

Firmware layer

- shows hardware, firmware and booter version of your MXm
- shows the same information concerning the connected expansions
- allows to check if more recent versions of firmware are available using "Firmware updates" buttons right of the layer.

7 – On the track

Some MXm pages are available for online visualization. To scroll them press “NEXT”. Pages can change according to the device configuration.

7.1 – Track page

This is the first page that appears when you switch MXm on and can be recalled pressing “TRACK” button Starting the engine of the car it goes away automatically. It shows:

- on the left, if you are in a 10km distance from the selected track, the same track; you can select a new one manually or automatically (“MENU/Track Management”); in case of “Automatic” selection the track is selected according to the position of your vehicle; if the track you are running on is not included in MXm database the logger switches to “learning mode” as shown in the bottom image here on the right
- on the right the satellite bar (visible satellites and signal level of each one).

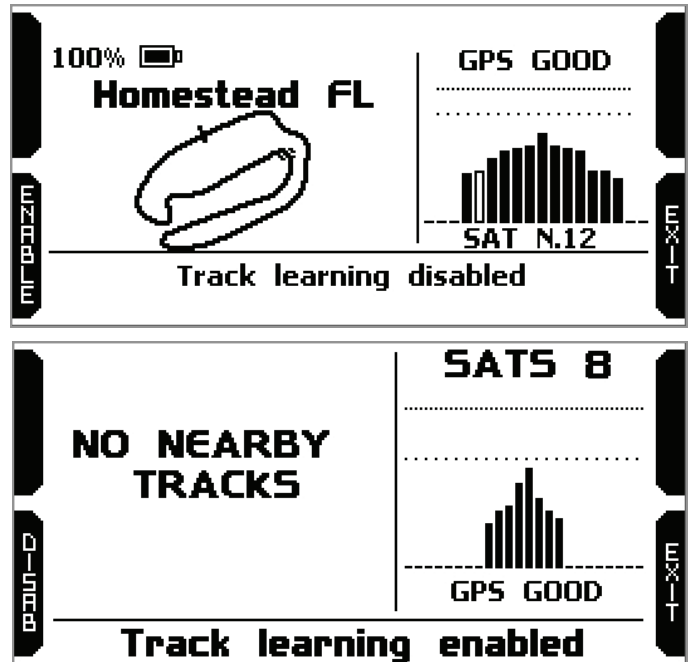

7.2 – Other pages

At very first switch on, when you quit track page MXm shows by default Laptime Page; afterwards it will show the last page you displayed.

As said before, MXm can show up to eight selected pages to be configured using Race Studio 3 software; use “>>” button to scroll among them.



8 – Data recall

At the end of the test you can recall sampled data pressing “MEM/OK”.

First page shown is a summary page
Select the session you want to see and press “ENTER”

| TEST SESSIONS | |
|--------------------------|--|
| TODAY: Albany GA | |
| 07/06/2020: Albany GA | |
| 02/06/2020: Albany-5a NY | |
| 15/10/2020: Avenger AL | |
| 05/10/2020: Auburndal | |

Once the session selected you enter session summary page where all tests in a box showing time of the test and best lap of the test.

Select the test you want to see and press “ENTER”.

| 17/09/2020: Albany GA | | |
|-------------------------------|-------------------------------|-------------------------------|
| 10:09 10 Laps B 2:23.56 | 12:26 18 Laps B 2:23.09 | 13:46 13 Laps B 2:22.90 |
| 14:36 10 Laps B 2:21.96 | 15:27 12 Laps B 2:22.06 | 16:06 16 Laps B 2:23.46 |

In page 1 (the number is top right of the page) you see the three best lap of the test with max speed value of each lap.
Press “PAGE”.

| 17/09/2020: 10:09 1 | | | |
|---------------------|-----------|-----|------------|
| MAX RPM | MAX SPEED | | |
| --- | 326 | | |
| Lap | Best Laps | RPM | km/h |
| 4 | 2:23.56 | --- | 131 118 |
| 11 | 2:25.11 | --- | 131 106 |
| 8 | 2:26.16 | --- | 130 96 |

Page 2 is a histogram test summary. Moving the cursor left and right you can see all laps and the difference versus the best lap of that test.

| 17/09/2020: 10:09 2 | |
|---------------------|--------------------------|
| Best: | 2:23.56 |
| Lap 3: | 2:25.88 Diff: 02.32 |

Page 3 shows lap time with speed max/min values.
Press “PAGE”.

| Lap 3 3 | | |
|----------|-----|-----------|
| Lap Time | RPM | km/h |
| 2:25.88 | --- | 130 96 |



Page 4 shows RPM graph of the selected lap.
Use "PREV" and "NEXT" buttons to see RPM and speed values in all points of the selected lap.

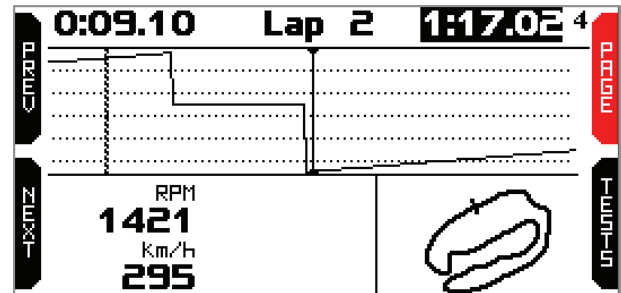

Page 5 shows the laps of the test with lap time, and RPM and Speed min/max values. Use:

- "PAGE" button to come back to page "1"
- "TESTS" buttons to come back to session summary page.

| TODAY 12:42 | | | | 5 |
|-------------|----------------------|---------------|------------|---|
| Lap | Lap Time | RPM | km/h | |
| 1 | 0:47.31 | 15710 7142 | 260 118 | |
| 2 | 1:17.02 ^B | 16375 7 | 450 100 | |
| 3 | 1:19.22 | 16372 13 | 331 100 | |
| 4 | 2:54.54 | 16379 4 | 450 1 | |

9 – Data download

Once MXm-PC connection is established activate “Download” tab to download sampled data.

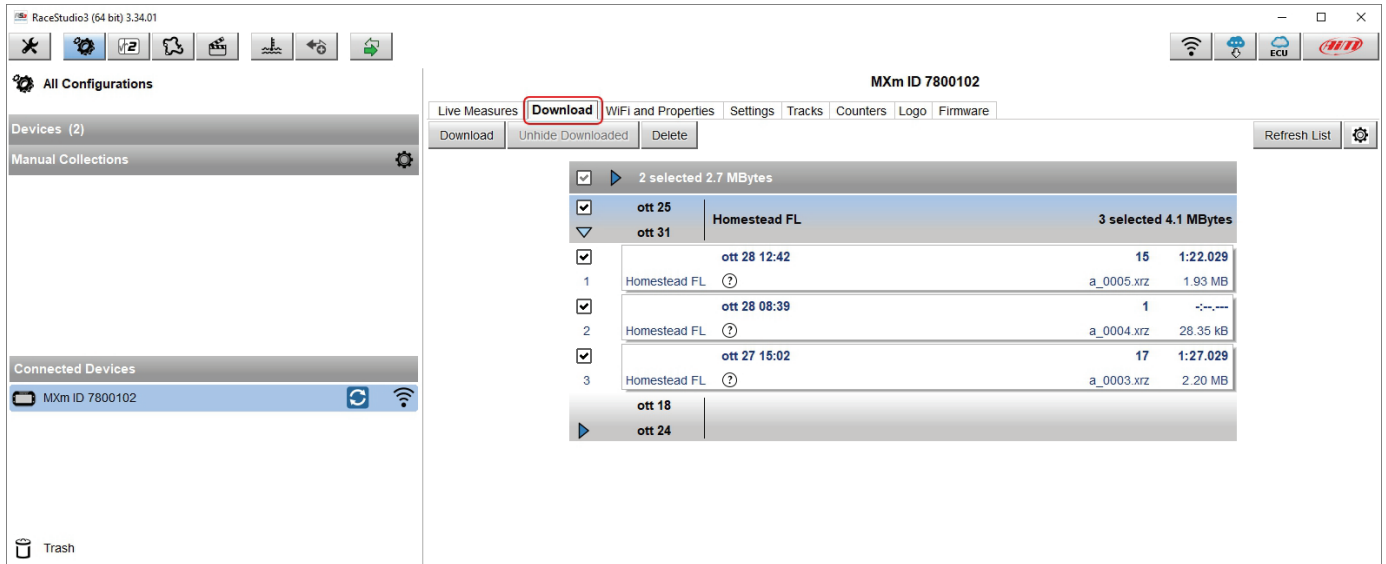

This page shows all information about the files stored in the system: number of laps, best lap, date/time and file dimensions. Select one or more files and press “Download” to download and analyse them.



10 – Data Analysis



When data have been downloaded press Analysis icon and Race Studio Analysis software will open showing this page.

The screenshot shows the RS2Analysis 2.56.84 software interface. The main window displays a 'Test database' table with the following data:

| Test name | Test date | ... | ... | ... | Best lap... | Driver | Test type | Ve... | Ch... | Track | C.. | File path | File name | |
|-----------------------|-------------------------------|-----|-----|-----|-------------|-----------|-----------------|-------|-------|--------------|-----|--|--------------------------------|----|
| John Hawk_Homestea... | Wed, Oct 28, 2020 08:26:57 AM | 11 | 10 | 1 | 01.43.830 | None | Generic testing | None | None | Homestead FL | C.. | C:\AIM_SPORT\RaceStudio3\user\data\2020-10-28\ | John Hawk_Homestead FL_a_00... | 19 |
| John Hawk_Homestea... | Wed, Oct 28, 2020 04:56:27 PM | 3 | 2 | 1 | 01.28.866 | John Hawk | Generic testing | None | None | Homestead FL | C.. | C:\AIM_SPORT\RaceStudio3\user\data\2020-10-28\ | John Hawk_Homestead FL_a_00... | 18 |
| John Hawk_Homestea... | Wed, Oct 28, 2020 04:47:27 PM | 2 | 1 | 1 | 01.29.359 | John Hawk | Generic testing | None | None | Homestead FL | C.. | C:\AIM_SPORT\RaceStudio3\user\data\2020-10-28\ | John Hawk_Homestead FL_a_00... | 17 |
| John Hawk_Homestea... | Wed, Oct 28, 2020 04:36:57 PM | 4 | 3 | 1 | 01.37.050 | John Hawk | Generic testing | None | None | Homestead FL | C.. | C:\AIM_SPORT\RaceStudio3\user\data\2020-10-28\ | John Hawk_Homestead FL_a_00... | 16 |
| John Hawk_Homestea... | Wed, Oct 28, 2020 03:57:06 PM | 2 | 2 | 1 | 01.32.687 | John Hawk | Generic testing | None | None | Homestead FL | C.. | C:\AIM_SPORT\RaceStudio3\user\data\2020-10-28\ | John Hawk_Homestead FL_a_00... | 15 |
| John Hawk_Homestea... | Wed, Oct 28, 2020 03:23:55 PM | 3 | 2 | 1 | 01.39.548 | John Hawk | Generic testing | None | None | Homestead FL | C.. | C:\AIM_SPORT\RaceStudio3\user\data\2020-10-28\ | John Hawk_Homestead FL_a_00... | 14 |
| John Hawk_Homestea... | Wed, Oct 28, 2020 03:17:05 PM | 4 | 2 | 1 | 01.30.956 | John Hawk | Generic testing | None | None | Homestead FL | C.. | C:\AIM_SPORT\RaceStudio3\user\data\2020-10-28\ | John Hawk_Homestead FL_a_00... | 13 |
| John Hawk_Homestea... | Wed, Oct 28, 2020 02:39:00 PM | 2 | 2 | 1 | 01.37.501 | John Hawk | Generic testing | None | None | Homestead FL | C.. | C:\AIM_SPORT\RaceStudio3\user\data\2020-10-28\ | John Hawk_Homestead FL_a_00... | 12 |
| John Hawk_Homestea... | Wed, Oct 28, 2020 02:30:09 PM | 5 | 3 | 1 | 01.32.859 | John Hawk | Generic testing | None | None | Homestead FL | C.. | C:\AIM_SPORT\RaceStudio3\user\data\2020-10-28\ | John Hawk_Homestead FL_a_00... | 11 |
| John Hawk_Homestea... | Wed, Oct 28, 2020 02:24:14 PM | 3 | 2 | 1 | 00.24.103 | John Hawk | Generic testing | None | None | Homestead FL | C.. | C:\AIM_SPORT\RaceStudio3\user\data\2020-10-28\ | John Hawk_Homestead FL_a_00... | 4 |
| John Hawk_Homestea... | Wed, Oct 28, 2020 02:05:51 PM | 5 | 2 | 1 | 01.39.070 | John Hawk | Generic testing | None | None | Homestead FL | C.. | C:\AIM_SPORT\RaceStudio3\user\data\2020-10-28\ | John Hawk_Homestead FL_a_00... | 9 |
| John Hawk_Homestea... | Wed, Oct 28, 2020 02:02:48 PM | 3 | 2 | 1 | 01.33.120 | John Hawk | Generic testing | None | None | Homestead FL | C.. | C:\AIM_SPORT\RaceStudio3\user\data\2020-10-28\ | John Hawk_Homestead FL_a_00... | 8 |
| John Hawk_Homestea... | Wed, Oct 28, 2020 02:00:08 PM | 3 | 2 | 1 | 01.37.768 | John Hawk | Generic testing | None | None | Homestead FL | C.. | C:\AIM_SPORT\RaceStudio3\user\data\2020-10-28\ | John Hawk_Homestead FL_a_00... | 7 |
| John Hawk_Homestea... | Wed, Oct 28, 2020 01:58:17 PM | 2 | 2 | 1 | 01.31.907 | John Hawk | Generic testing | None | None | Homestead FL | C.. | C:\AIM_SPORT\RaceStudio3\user\data\2020-10-28\ | John Hawk_Homestead FL_a_00... | 6 |

At the bottom of the table, there are buttons for 'Open test', 'Close test', 'Test properties', 'Import test', 'Remove test', and 'Export test'. Below the table is a 'Test Database' tab and a 'Test laps' section.



Select the desired file double clicking on it and start analysing sampled data. A lot of pages, graphs and images will be available.

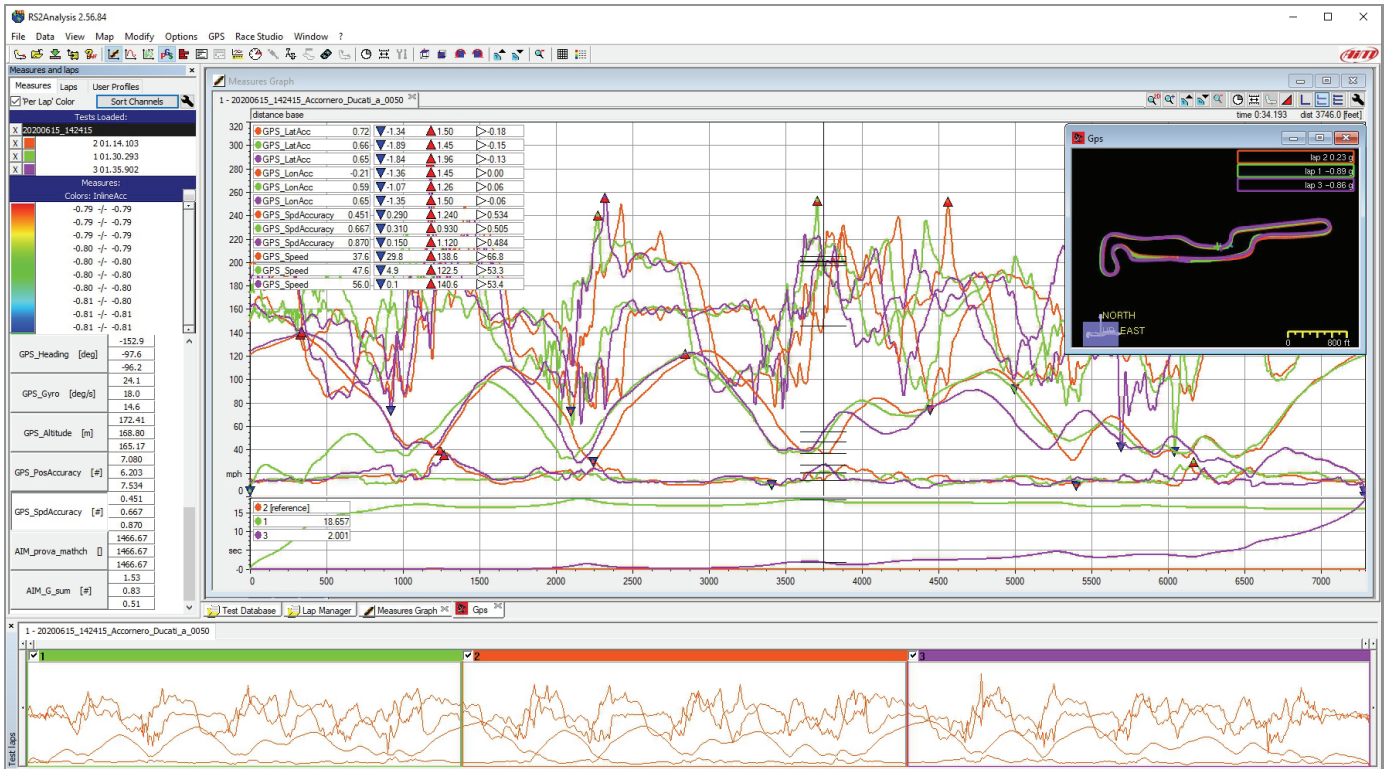

11 – New firmware upgrade



Our technicians and engineers are constantly working to improve both the firmware (the application that manages your device) and the software (the application you install on your PC).

Each time a new firmware and/or software version is available the icon here above appears with an arrow indicating that something is available for download (otherwise the icon only shows the cloud).

Click it and freely download the new applications.

The screenshot shows the RaceStudio3 (64 bit) 3.34.01 interface. On the left, a 'Connected Devices' panel shows 'MXm ID 7800102'. The main area has a menu bar with 'Download', 'Install SW', 'Export', 'Import', and 'Update Device'. Below the menu is a table with columns: 'Name', 'On the web', 'Downloaded', and 'Info'. The table is divided into 'Software' and 'Firmware' sections. The 'MXm' firmware version 02.32.78 is highlighted with a red box, indicating it is a new update. The 'MyChron5S' software version 02.34.24 is also highlighted.

| Name | On the web | Downloaded | Info |
|---|-----------------|-----------------|------|
| Software (Installed version: 'RaceStudio3 (64 bit) 3.34.01') | | | |
| <input type="checkbox"/> RaceStudio3 (64 bit) | 3.34.01 | 3.32.14 | |
| Firmware | | | |
| <input type="checkbox"/> EVO4S | 01.30.00 | 01.30.00 | |
| <input type="checkbox"/> EVO5 | 01.30.00 | 01.30.00 | |
| <input type="checkbox"/> MXG | 01.30.00 | 01.30.00 | |
| <input type="checkbox"/> MXL2 | 01.30.00 | 01.30.00 | |
| <input type="checkbox"/> MXS | 01.30.00 | 01.30.00 | |
| <input type="checkbox"/> MXS Strada | 01.30.00 | 01.30.00 | |
| <input type="checkbox"/> MyChron5 | 01.30.00 | 01.30.00 | |
| <input type="checkbox"/> SmartyCam HD | 01.04.32 | 01.04.32 | |
| <input type="checkbox"/> MX2E | 02.34.07 | 02.34.07 | |
| <input type="checkbox"/> MXG 1.2 | 02.32.81 | 02.32.81 | |
| <input type="checkbox"/> MXG 1.2 Strada | 02.32.81 | 02.32.81 | |
| <input type="checkbox"/> MXK10 | 02.28.33 | 02.28.33 | |
| <input type="checkbox"/> MXK10(11-15) | 02.28.12 | 02.28.12 | |
| <input type="checkbox"/> MXP | 02.32.81 | 02.32.81 | |
| <input type="checkbox"/> MXP Strada | 02.32.81 | 02.32.81 | |
| <input type="checkbox"/> MXS 1.2 | 02.32.81 | 02.32.81 | |
| <input type="checkbox"/> MXS 1.2 Strada | 02.32.81 | 02.32.81 | |
| <input type="checkbox"/> MX GTV | 02.34.10 | 02.34.10 | |
| <input checked="" type="checkbox"/> MXm | 02.32.78 | 02.32.72 | |
| <input type="checkbox"/> MXSI | 02.32.78 | 02.32.78 | |
| <input checked="" type="checkbox"/> MyChron5S | 02.34.24 | | |
| <input type="checkbox"/> Solo 2 | 02.32.86 | 02.32.86 | |

Once the new firmware has been downloaded connect your device to the PC via Wi-Fi to perform a firmware upgrade. In a few seconds the device is ready.

12 – RPM

MXm can receive RPM value from the ECU. If on the contrary your vehicle does not have an ECU you can sample RPM using the wire labelled “RPM” of 37 pins connector harness you find in the kit.

12.1 – RPM from ECU

To get the RPM from the ECU you only need to connect your MXm to the ECU and it will automatically sample that value.

12.2 – RPM via a 5-50V square wave or coil (150-400V)

If your vehicle has no ECU you need to connect the wire labelled RPM of 37 pins connector harness to the ignition system. This way MXm can read the signal from the low voltage of the coil (whose peak can be from 150 to 400 V) or from a possible square wave (the peak can be from 5 to 50 V).

The image below shows an example of wiring of the ignition system.

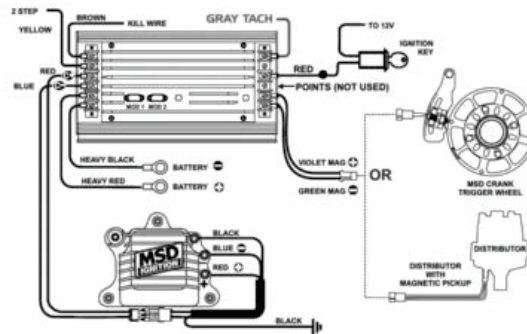

The output labelled “GRAY TACH” gives a 5-50V output that can be directly sampled by MXm.

In case the vehicle ignition system has no output you need to connect MXm to the low voltage of the coil as shown in the following images.

Point 1: low voltage of the coil

Point 2: connected to the spark plug

Point 3: connected to the +12V of the battery

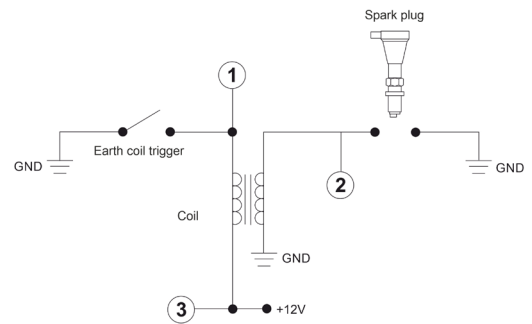
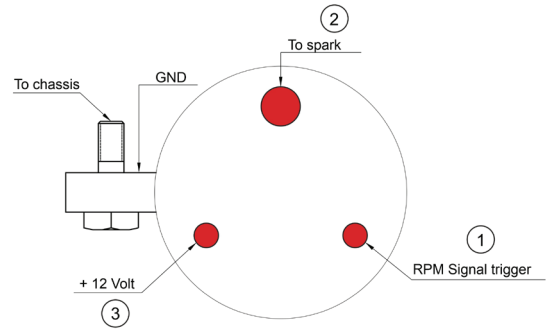



Once MXm connected to RPM signal you can set its parameters in channels page of Race Studio 3 as explained in “Channels configuration” paragraph.

The screenshot shows the RaceStudio3 interface with the Channels configuration window open. The window title is "RaceStudio3 (64 bit) 3.34.01". The main menu includes "Channels", "ECU Stream", "CAN Expansions", "Math Channels", "Status Variables", "Parameters", "Shift Lights and Alarms", "Power Outputs", "Display", "SmartyCam Stream", and "CAN Output". The Channels list on the left includes various sensors like RPM, Speed1, Speed2, Front Brake Pres, Rear Brake Press, Channel03, Channel04, InlineAcc, LateralAcc, VerticalAcc, RollRate, PitchRate, YawRate, GPS Accuracy, GPS Speed, Altitude, Odometer, Luminosity, and LoggerTemp. The RPM channel is selected, and its settings are shown in a "Channel Settings" dialog box. The dialog has fields for Name (RPM), Function (Engine RPM), Sensor (RPM Sensor), and Sampling Frequency (20 Hz). Below these are "RPM Parameters" with RPM Max (16000) and RPM Factor (/1). A "Name already used" error message is visible at the bottom of the dialog. The dialog also has "Save" and "Cancel" buttons.

| ID | Name | Function | Sensor | Unit | Freq | Parameters |
|------|------------------|----------------|--------------------|------|------|------------|
| RPM | RPM | Engine RPM | RPM Sensor | | | |
| Spd1 | Speed1 | Vehicle Spd | | | | |
| Spd2 | Speed2 | Vehicle Spd | | | | |
| Ch01 | Front Brake Pres | Brake Press | | | | |
| Ch02 | Rear Brake Press | Brake Press | | | | |
| Ch03 | Channel03 | Voltage | | | | |
| Ch04 | Channel04 | Voltage | | | | |
| Acc1 | InlineAcc | Inline Accel | | | | |
| Acc2 | LateralAcc | Lateral Accel | | | | |
| Acc3 | VerticalAcc | Vertical Accel | | | | |
| Gyr1 | RollRate | Roll Rate | | | | |
| Gyr2 | PitchRate | Pitch Rate | | | | |
| Gyr3 | YawRate | Yaw Rate | | | | |
| Accu | GPS Accuracy | GPS Accurac | | | | |
| Spd | GPS Speed | Vehicle Spd | | | | |
| Alt | Altitude | Altitude | | | | |
| OdD | Odometer | Odometer Tc | | | | |
| Luma | Luminosity | Brightness | | | | |
| Tlog | LoggerTemp | Temperature | Logger Temperature | C | 1 Hz | |

13 – Connection with SmartyCam and LCU-One

Your MXm can be connected to AiM SmartyCam HD, SmartyCam GP HD and LCU-One CAN as shown in the images below.

Please remember that all channels transmitted by these AiM expansions have to be set in Race Studio 3 software as already explained in the related paragraphs (“LCU-One CAN setting” and “SmartyCam stream setting”).

Moreover for further information concerning SmartCam HD, SmartyCam GP HD and LCU One refer to the related manuals you can download from “Documentation” area of AiM website www.aim-sportline.com.

To connect MXm to SmartyCam HD connect SmartyCam CAN cable to the cable labelled “EXP” of MXm 37 pins connection harness and 7 pins Binder connector of SmartyCam CAN cable to 7 pins Binder connector placed rear left of SmartyCam HD as shown here below.



To connect MXm to SmartyCam GP HD connect SmartyCam CAN cable to the cable labelled “EXP” of MXm 37 pins connector harness and 7 pins Binder connector of SmartyCam HD CAN cable to the recorder central connector as shown here below.



To connect MXm to LCU-One CAN connect cable labelled “EXP” of MXm 37 pins connector harness to 5 pins Binder connector of LCU-One as shown here below.





14 – Technical specifications and drawings

| | |
|-----------------------------|--|
| • Display resolution | 268x128 pixels |
| • Display pages | Up to 8 freely configurable |
| • Backlight | 7 configurable RGB colour |
| • Ambient light sensor | Yes |
| • Shift lights | 5 configurable RGB LEDs |
| • Alarm LEDs | 2 configurable RGB LEDs |
| • CAN connections | 2 |
| • Analog inputs | 4 fully configurable, max 1.000 Hz each |
| • Digital inputs | 2 speed inputs, coil RPM input |
| • Digital outputs | 2 high side |
| • Integrated track database | Yes |
| • Inertial platform | 9 axis internal platform |
| • Wi-Fi connection | Yes |
| • Integrated GPS | 10Hz GPS+Glonass |
| • ECU Connection | CAN, RS232, K-Line |
| • External power | 12V |
| • Memory | 4GB |
| • Pushbuttons | Metallic |
| • Connectors | 37 pins motorsport connector + 4 pins power connector |
| • Body | Glass fiber reinforced Nylon |
| • Weight | 330g |
| • Dimensions | 137x88.4x31.9mm |
| • Waterproof | IP65 |
| • Analysis software | Race Studio Analysis freely downloadable from www.aim-sportline.com |

MXm pinout

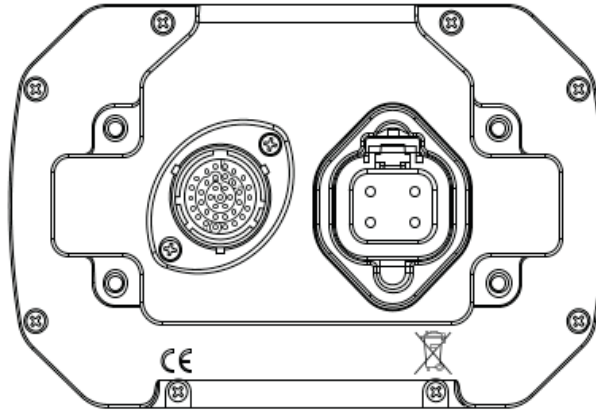

37 pins Motors port
male connector
front view

4 pins power
male connector
front view

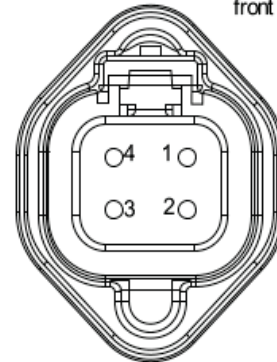
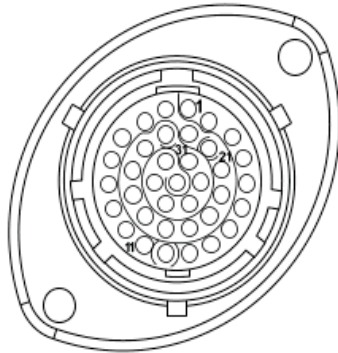

| Pin | Pin function |
|-----|-------------------|
| 1 | 9-15V Power input |
| 2 | Battery Ground |
| 3 | CAN+ Exp |
| 4 | Ground |
| 5 | +Vbattery CAN |
| 6 | CAN- exp |
| 7 | +Vbext |
| 8 | CAN1+ ECU/RS232TX |
| 9 | CAN1- ECU/RS232RX |
| 10 | Ground |
| 11 | ECU K-Line |
| 12 | USB D+ |
| 13 | USB D- |
| 14 | Ground |
| 15 | RPM |
| 16 | Ground |
| 17 | +Vbattery |
| 18 | Speed2 |
| 19 | Speed1 |

| Pin | Pin function |
|-----|----------------|
| 20 | Ground |
| 21 | +Vbattery |
| 22 | Analog Input 1 |
| 23 | Analog GND |
| 24 | +Vbattery |
| 25 | +Vreference |
| 26 | Analog Input 2 |
| 27 | Analog GND |
| 28 | +Vbattery |
| 29 | +Vreference |
| 30 | Analog Input 3 |
| 31 | Analog GND |
| 32 | +Vbattery |
| 33 | +Vreference |
| 34 | Analog Input 4 |
| 35 | Analog GND |
| 36 | +Vbattery |
| 37 | +Vreference |

| Pin | Pin function |
|-----|--------------------|
| 1 | High side output 2 |
| 2 | 9-15V power input |
| 3 | 9-15V power input |
| 4 | High side output1 |



MXm dimensions in mm [inches]

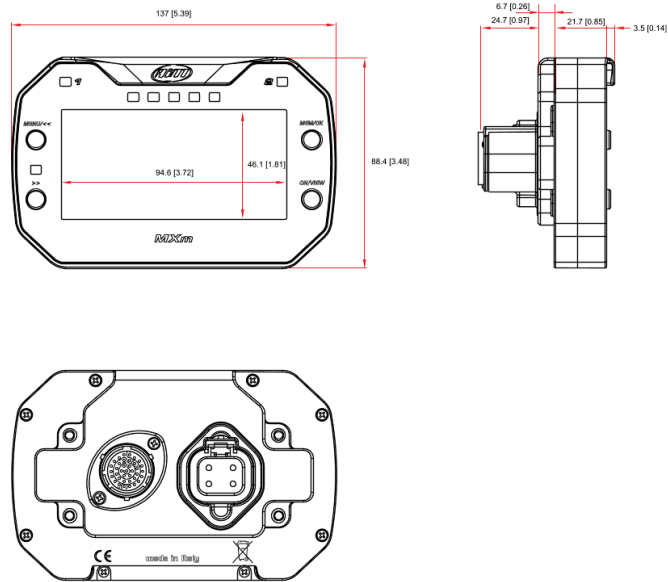

MXm 37 pins Deutsch connector harness

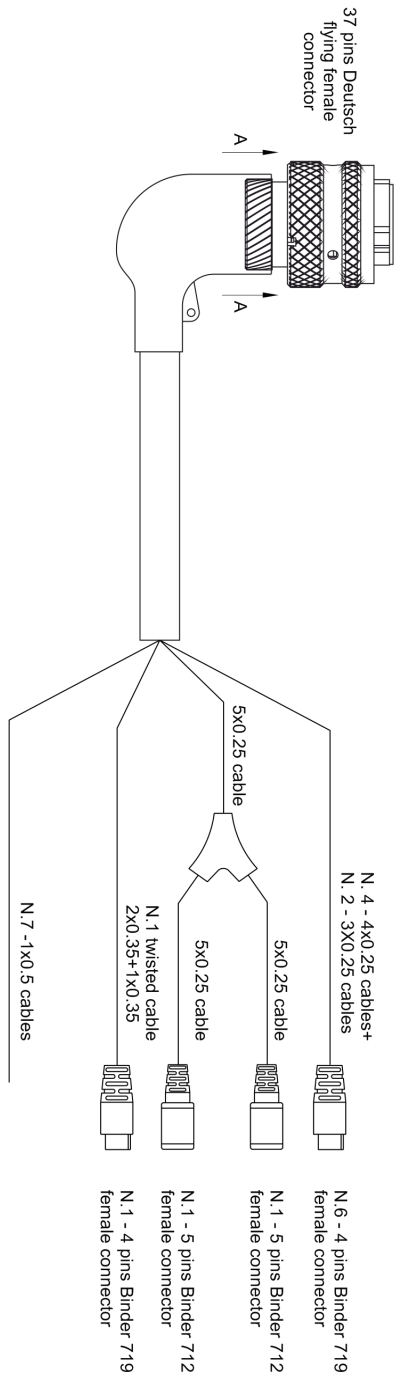

Harness front view

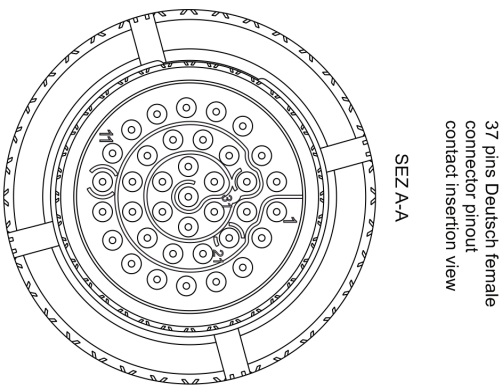
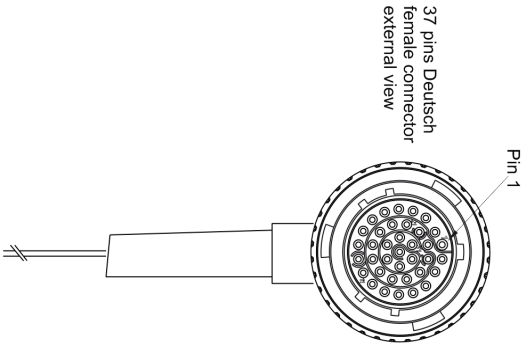

| Cables ending with 4 pins Binder 719 female connector | | | | | | |
|---|--|---------------------------|--------------------------|---------|--|-----------|
| 37 pins Deutsch connector pin | Cable colour | Destination connector pin | Cable Type | Length | Channel | Label |
| 22 23 24 25 | White Black Red Blue | 1 2 3 4 | 4x0.25mm ² | 340 mm | +Analog input 1 GND Vbattery Vreference | Channel 1 |
| 26 27 28 29 | White Black Red Blue | 1 2 3 4 | 4x0.25mm ² | 340 mm | +Analog input 2 GND Vbattery Vreference | Channel 2 |
| 30 31 32 33 | White Black Red Blue | 1 2 3 4 | 4x0.25mm ² | 360 mm | +Analog input 3 GND Vbattery Vreference | Channel 3 |
| 34 35 36 37 | White Black Red Blue | 1 2 3 4 | 4x0.25mm ² | 360 mm | +Analog input 4 GND Vbattery Vreference | Channel 4 |
| 19 20 21 | White Black Blue n.c. | 1 2 3 4 | 3x0.25mm ² | 320 mm | Speed 1 GND Vbattery n.c. | Speed 1 |
| 18 16 17 | White Black Blue n.c. | 1 2 3 4 | 3x0.25mm ² | 320 mm | Speed 2 GND Vbattery n.c. | Speed 2 |
| 12 14 13 | White twisted Black Blue twisted n.c. | 1 2 3 4 | Twisted 2x0.35+1x0.35 | 1100 mm | USB D+ GND USB D- n.c. | USB |

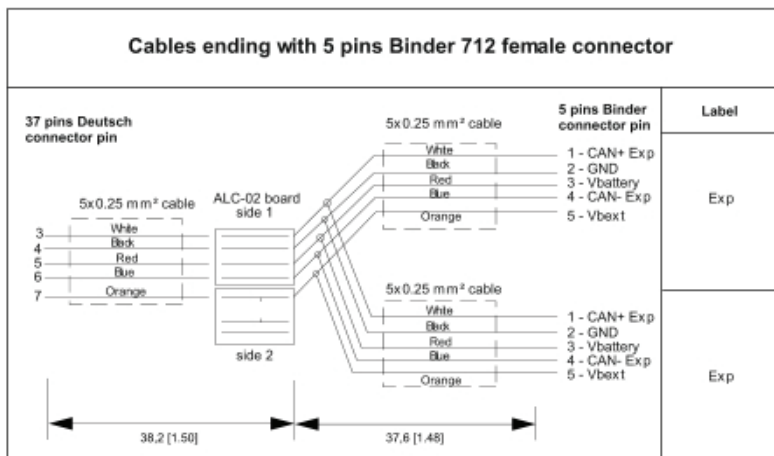

| Flying leads | | | | |
|-------------------------------|--------------------------------|--|--------|--|
| 37 pins Deutsch connector pin | Cable colour | Cable type | Length | Label |
| 15 | White | 1x0.5 mm ² | 550 mm | RPM |
| 2 1 | Black Red | 1x0.5 mm ² 1x0.5 mm ² | 550 mm | GND 9-15V Power input |
| 8 9 10 11 | White Blue Black Blue | 1x0.5 mm ² 1x0.5 mm ² 1x0.5 mm ² 1x0.5 mm ² | 550 mm | CAN 1+ ECU RS232TX CAN 1- ECU RS232RX Kline GND kLINE |